



08.2007 EvoBus GmbH

Not to be reprinted, reproduced or translated in any form without prior permission.

**Address for orders:**

EvoBus GmbH  
Service Documentation  
D-89077 Ulm

Printed in Germany

**Order no.:** A 628 584 32 97

## Introduction

**The user information supplied with each bus is only intended for use by those persons who are qualified to operate the bus. The user information is split into the following parts:**

- The Driver's Operating Instructions are intended to answer all important questions concerning operation of the bus in a concise and clearly understandable manner.
- More detailed and complete information, as well as further information relevant to safety, can be found in the Operating Instructions.
- The Maintenance Record serves as a guide to the technical care of the bus. It contains all the information on maintenance intervals and maintenance tasks as well as pages for confirming that the maintenance work has been carried out.

Please make sure that you read the "Safety" section before you use the vehicle for the first time. Before the bus is driven, please make sure that you have read and understood the contents of these Operating Instructions.

Items of optional equipment are also described, if their operation needs explanation. The bus delivered to you has been customised in accordance with your order, therefore some descriptions and diagrams may differ from the equipment on your bus.

The Driver's Operating Instructions, the Operating Instructions and Maintenance Record are important documents and must always be carried in the bus.

Our buses are the subject of ongoing development. You are therefore asked to appreciate that we reserve the right to make modifications to the design, equipment and technical features. For these reasons, no claims can be made based upon the contents of this user information.

## Environmental protection:

The declared policy of EvoBus GmbH is one of integrated environmental protection. This policy starts at the root causes and encompasses in its management decisions all the consequences for the environment which could arise from production processes or the products themselves.

The objectives are for the natural resources which form the basis of our existence on this planet to be used sparingly and in a manner which takes the requirements of both nature and humanity into account.

You can also help the environment by operating the bus in an environmentally-friendly manner. Fuel consumption and wear in the drive train (engine, clutch, transmission, axles, brakes, tyres) are extremely dependent on your driving style.

We hope you enjoy driving your bus.

EvoBus GmbH

Mercedes-Benz Omnibusse



|  |    |   |    |  |    |
|--|----|---|----|--|----|
| <b>Vehicle identification</b> . . . . .              | 1  | Front towing coupling . . . . .   | 23 | Replacing the fuel filter . . . . .  | 40 |
| <b>Safety</b> . . . . .                              | 3  | Rear towing coupling (option, not applicable to Conecto G) . . . . .                          | 24 | Addition of petrol . . . . .   | 40 |
| General safety information . . . . .                 | 4  | Brake system safety precautions . . . . .   | 25 | Addition of flow improvers . . . . .   | 40 |
| Windscreen wiper system safety precautions . . . . . | 8  | Braking and stopping . . . . .  | 26 | Measures required in the event of inadequate low-temperature characteristics . . . . . | 41 |
| Operation of auxiliary heating . . . . .             | 8  | Brakes with anti-locking protection . . . . .   | 26 | Measures required in the event of pre-existing paraffin separation . . . . .           | 41 |
| <b>General</b> . . . . .                             | 11 | Brake pressure/supply pressure (operating pressure) . . . . .                                 | 27 | Winter operation with FAME biodiesel . . . . .   | 42 |
| Preparation for the journey - daily tasks . . . . .  | 12 | Brake system operating/malfunction displays . . . . .   | 28 | Opening/closing the fuel filler cap . . . . .  | 42 |
| Preparation for the journey - weekly tasks . . . . . | 13 | Activating/deactivating acceleration skid control (ASR) (option) . . . . .                    | 31 | Filling with AdBlue (Euro 4) . . . . .   | 44 |
| General bus care and maintenance . . . . .           | 14 | Operating/malfunction displays ABS/ASR . . . . .  | 31 | Fuel system operating/malfunction displays . . . . .                                   | 46 |
| Care and cleaning . . . . .                          | 14 | Refuelling (diesel fuel) . . . . .  | 33 | Anti-jackknifing protection during forward travel . . . . .                            | 47 |
| <b>Operation</b> . . . . .                           | 15 | Service products . . . . .  | 34 | Anti-jackknifing protection during reverse travel . . . . .                            | 48 |
| Running-in guideline . . . . .                       | 18 | BlueTec exhaust gas cleaning system . . . . .   | 35 | Stop request . . . . .   | 49 |
| Starting the engine . . . . .                        | 18 | AdBlue service product . . . . .  | 37 | Ramp request . . . . .   | 50 |
| Driving . . . . .                                    | 20 | Winter operation with diesel fuels for buses with fuel-lubricated injection systems . . . . . | 38 | Safety instructions for the operation of folding/cassette ramps (option) . . . . .     | 51 |
| Stopping the engine . . . . .                        | 21 | Low-temperature characteristics of diesel fuels . . . . .                                     | 39 | Folding the ramp in/out . . . . .  | 52 |
| Towing . . . . .                                     | 22 | Diesel fuels available by region . . . . .  | 39 | Retracting/extending the ramp . . . . .  | 54 |

## Table of contents

|   |           |   |           |  |     |
|---|-----------|---|-----------|--|-----|
| Opening the hinged window . . . . .                             | 56        | Tachograph (display) . . . . .  | 83        | Malfunction displays: yellow warning level A - description . . . . .       | 120 |
| Care and cleaning . . . . .                                     | 57        | Location of emergency equipment . . . . .                                   | 84        | Malfunction displays: yellow warning level A - overview . . . . .          | 122 |
| Tilting the rear seats . . . . .                                | 58        | Windscreen washer reservoir . . . . .                                       | 86        | Malfunction displays: yellow warning level B - description . . . . .       | 124 |
| Tilting seats . . . . .   | 59        |   |           | Malfunction displays: yellow warning level B - overview . . . . .          | 126 |
| Care and cleaning of covers and upholstery . . . . .            | 59        | <b>Driver's area controls . . . . .</b>                                     | <b>89</b> | Malfunction displays: warning level C - description . . . . .              | 127 |
| Care/cleaning of fabric covers . . . . .                        | 60        | Rotary light switch . . . . .   | 91        | Malfunction displays: warning level C - overview . . . . .                 | 128 |
| Care/cleaning of micro-fibre covers . . . . .                   | 61        | Steering column switch for light and wiper functions . . . . .              | 92        | Selecting the language on the screen . . . . .                             | 129 |
| Care/cleaning of leather covers . . . . .                       | 63        | Steering column switch for retarder and cruise control (overview) . . . . . | 92        | General Information / Safety Information . . . . .                         | 131 |
| <b>At a glance . . . . .</b>                                    | <b>65</b> | Ignition switch . . . . .   | 98        | Lowering/raising the bus on the entry side . . . . .                       | 132 |
| Overview of vehicle key . . . . .                               | 66        | Parking brake . . . . .   | 99        | Raising the bus above normal level . . . . .                               | 134 |
| Driver's area overview . . . . .                                | 68        | Master safety switch (emergency-off switch) . . . . .                       | 100       | Applying the parking brake . . . . .                                       | 136 |
| Switches on the left section of the instrument panel . . . . .  | 69        | Screen: description . . . . .   | 101       | Releasing the parking brake . . . . .                                      | 137 |
| Switches on the right section of the instrument panel . . . . . | 71        | Operating displays/driving mode/bus stop mode . . . . .                     | 102       | Emergency braking in the event of failure of both brake circuits . . . . . | 138 |
| Side panel . . . . .  | 73        | Continuation: bus stop mode . . . . .                                       | 114       | Activating/deactivating the bus stop brake . . . . .                       | 139 |
| Instrument cluster . . . . .                                    | 76        | Malfunction displays: description . . . . .                                 | 116       | Drive-off lock . . . . .   | 140 |
| MTCO tachograph . . . . .                                       | 80        | Malfunction displays: red warning level - description . . . . .             | 117       |  |     |
| DTCO tachograph . . . . .                                       | 82        | Malfunction displays: red warning level - overview . . . . .                | 118       |  |     |

General Information / Safety Information . . . . . 141  
 Adjusting the steering column . . . . . 142  
 Turning the steering wheel when the bus is stationary . . . . . 142  
 Switching the mirror and window heating on and off . . . . . 143

**Driver's seat/passenger seats . . . . . 145**  
 Important notes on the driver's seat . . . . . 146  
 Grammer MSG 90.5 driver's seat control elements . . . . . 148  
 Using the driver's seat belt . . . . . 150

**Transmission shift systems . . . . . 151**  
 Automatic transmission - general information . . . . . 152  
 Gearshift positions of the 3-pushbutton switch panel . . . . . 153  
 Gearshift positions of the 6-pushbutton switch panel . . . . . 154

**Heating/ventilation/air-conditioning . . . . . 159**  
 Safety instructions for the air-conditioning system . . . . . 161  
 Operating instructions for the air-conditioning system . . . . . 161  
 Heating/ventilation/air-conditioning control panel - driver's area . . . . . 162  
 Heating/ventilation/air-conditioning control panel - whole bus . . . . . 164  
 Driver's area - setting the air distribution/demisting the wind-screen . . . . . 165  
 Driver's area - adjusting the temperature . . . . . 166  
 Driver's area - adjusting the blower speed . . . . . 167  
 Driver's area - cooling . . . . . 168  
 Additional driver's area ventilation (option) . . . . . 169  
 Switching air-recirculation mode on and off . . . . . 169  
 Passenger compartment - switching temperature control on and off - code HH2/HK1 . . . . . 170

Passenger compartment - switching temperature regulation on and off . . . . . 171  
 Switching the auxiliary heating on and off . . . . . 172  
 Switching the reheat function on and off . . . . . 174  
 Passenger-compartment temperature - changing the base value . . . . . 175  
 Opening the roof hatches . . . . . 179  
 Fans on/off . . . . . 181  
 Switching fans on and off - code HH2/HK1 . . . . . 182  
 Auxiliary heating digital timer (option) . . . . . 184  
 Auxiliary heating operation (option) . . . . . 185

**Opening/locking . . . . . 189**  
 General Information / Safety Information . . . . . 190  
 Emergency operation - doors . . . . . 192  
 Opening/closing door 1 from the outside . . . . . 194

## Table of contents

|  |            |   |     |   |     |
|--|------------|---|-----|---|-----|
| Locking/unlocking door leaves from the outside . . . . .             | 195        | Operating safety and roadworthi-<br>ness . . . . .  | 217 | Emergency release of the drive-off<br>lock . . . . .  | 230 |
| Opening/closing door 1 from the<br>outside . . . . .                 | 195        | Tyre pressure . . . . .   | 217 | Parking brake emergency release<br>(option) . . . . .   | 231 |
| Opening/closing door 1 from the<br>outside . . . . .                 | 196        | Tyre tread . . . . .  | 218 | Electrical system safety precau-<br>tions . . . . .   | 232 |
| Locking door 1 with the key<br>(option) . . . . .                    | 197        | Tyre condition . . . . .  | 218 | General safety precautions for<br>batteries . . . . .   | 233 |
| Locking/unlocking the door leaves<br>from the inside . . . . .       | 197        | Tyre age . . . . .  | 218 | Safety precautions for handling<br>batteries . . . . .  | 233 |
| Opening/closing the doors from the<br>inside . . . . .               | 198        | Invisible tyre damage . . . . .   | 219 | Battery maintenance . . . . .   | 234 |
| Opening/closing automatic doors<br>from the inside . . . . .         | 199        | Tyre load capacity, top speed of<br>tyres and types of tyres . . . . .                    | 219 | Recharging the batteries . . . . .  | 235 |
| Opening/closing automatic doors<br>from the outside . . . . .        | 201        | Retreaded tyres . . . . .   | 220 | Working on the electrical system<br>and electrical fuses . . . . .  | 235 |
| Opening/closing automatic<br>doors . . . . .                         | 203        | Cleaning the tyres . . . . .  | 220 | Measures required for the pre-<br>vention of damage to buses or<br>components during electric welding<br>work . . . . . | 236 |
| <b>Practical advice . . . . .</b>                                    | <b>207</b> | Retightening the wheel nuts . . . . .   | 220 | Switching the on-board power<br>supply on/off . . . . .   | 237 |
| General Information / Safety<br>Information . . . . .                | 210        | Wheel nut tightening torques . . . . .  | 221 | Switching off the on-board power<br>supply at the master safety<br>switch . . . . .                                     | 238 |
| Engine oil level: oil level informa-<br>tion on the screen . . . . . | 210        | Snow chains . . . . .   | 221 | Jump-starting where vehicle bat-<br>teries are located one above the<br>other . . . . .                                 | 239 |
| General Information / Safety<br>Information . . . . .                | 213        | Tyre air pressure chart. . . . .  | 224 |   |     |
|  |            | Safety measures to be taken in<br>the event of a flat tyre or a wheel<br>change . . . . . | 226 |   |     |
|  |            | Jacking points . . . . .  | 226 |   |     |
|  |            | Safety measures to be taken in<br>the event of a flat tyre or a wheel<br>change . . . . . | 228 |   |     |
|  |            | Jacking points, front . . . . .   | 228 |   |     |
|  |            | Jacking points, centre (CONECTO<br>G) . . . . .   | 229 |   |     |
|  |            | Jacking points, rear . . . . .  | 229 |   |     |



Jump-starting where vehicle  
batteries are mounted side by  
side . . . . . 242

Jump-starting a bus fitted with a  
battery charging socket . . . . . 244

Opening the emergency exit in the  
roof . . . . . 245

Note on maintenance work . . . . . 247

Cleaning the underbody . . . . . 247

---

**Technical data . . . . . 253**

Vehicle data . . . . . 254

---

**Index . . . . . 255**



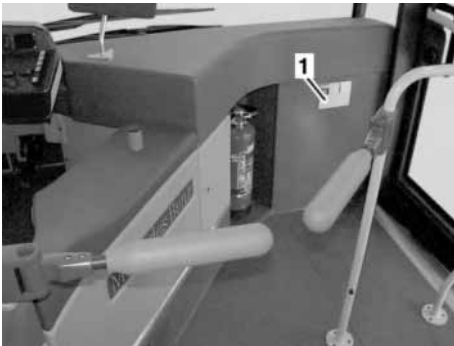

M00.01-0003-01

The vehicle identification plate with the vehicle identification number (VIN) and data concerning permissible weights is located on the forward structure near the front entrance.



**Note:**

It is very important to identify the vehicle exactly so that the correct "vehicle data" can be assigned. You will also need the VIN when ordering replacement parts and making technical enquiries.

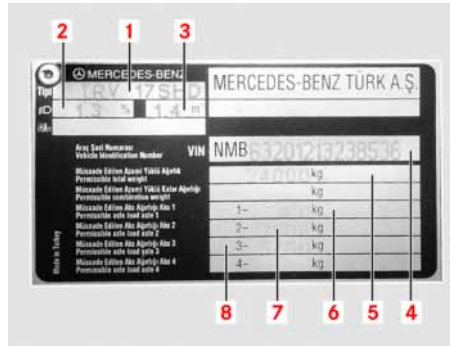

M00\_00-0315-01

| No. | Designation                         | Value |
|-----|-------------------------------------|-------|
| 1   | Vehicle designation                 |       |
| 2   | Headlamp basic setting              |       |
| 3   | Headlamp basic setting              |       |
| 4   | Vehicle Identification Number (VIN) |       |
| 5   | Permissible gross vehicle weight    |       |

| No. | Designation                          | Value |
|-----|--------------------------------------|-------|
| 6   | Permissible axle load for front axle |       |
| 7   | Permissible axle load for 2nd axle   |       |
| 8   | Permissible axle load for 3rd axle   |       |

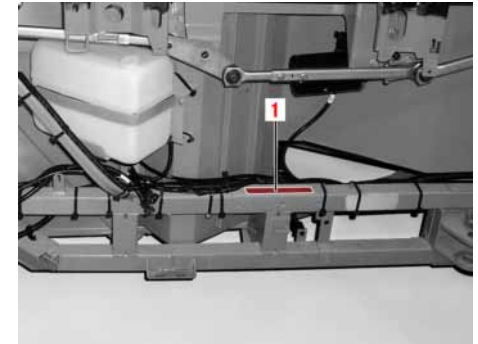

M00\_00-0491-71

Vehicle identification number (1) is also marked on the skeleton at the front of the bus. It is accessible via the front flap.



|   |          |
|---|----------|
| <b>General safety information</b> .....                 | <b>4</b> |
| <b>Windscreen wiper system safety precautions</b> ..... | <b>8</b> |
| <b>Operation of auxiliary heating</b> .....             | <b>8</b> |

## General safety information

### General safety information

#### The use of symbols and their meanings

Safety precautions and other important instructions are highlighted by symbols.

In addition to the instructions listed in the contents, the safety and accident prevention regulations issued by German Employer's Liability Insurance Associations must be observed.

Instructions and information printed on the packaging for components, tools and service products must also be observed.

Where information and instructions are to be observed, it is also assumed that the user information is intended for persons who are suitably qualified to carry out the tasks by nature of their education, training and experience.

At the same time, these persons should be able to identify risks that may arise in the undertaking of their tasks and take the necessary measures to avoid them.

Meaning of symbols:



#### Note:

Notes about important additional information



#### Caution:

Warning notes about damage that may occur in the event of non-compliance



#### Danger.

Warning notes for risks to persons



#### Environmental protection

Notes about environmental protection measures

▷ Reference to more detailed and additional user information

### Notes on vehicle safety

We recommend that you:

- Use only genuine parts that are OM-NIplus quality tested and conversion parts and accessories that have been expressly approved by EvoBus for the bus model concerned in order to rule out the possibility of jeopardising road safety and invalidating the warranty and general operating permit. These parts have been specially tested for their safety, reliability and suitability.

You can obtain further information from any EvoBus Service Partner.

### Operating safety

Important notes:

- Any work or modifications that have been carried out incorrectly on the bus may result in malfunctions.
- Tampering with electronic components and their software may cause malfunctions. As electronic components are networked, these malfunc-

## General safety information

- tions may also cause other, indirectly related systems to malfunction. These malfunctions may jeopardise the operating safety and reliability of the bus.
- Retrofitted electrical or electronic devices must possess type-approval complying with Directive 95/54/EC or ECE Directive 10/02.
  - Materials that are fitted in the bus during the course of installation, conversion or modification work and that are subject to mandatory fire-testing requirements must also satisfy the conditions of EU Directive 95/28/EC.
  - Materials and components in seats and seat fixtures that are also fitted in the bus during the course of installation, conversion or modification must also satisfy the following directives: 76/115/EEC as amended by 96/38/EC, 74/408/EEC as amended by 96/37/EC, 77/541/EEC as amended by 96/36/EC,
  - When such materials and components are purchased or installed, care shall be taken to ensure that they are appropriately certified. Use of materials and components that do not possess the certificate referred to above can result in the operating permit being invalidated.
  - We recommend that you have any work or modifications carried out by an EvoBus Service Partner.

### Stickers

There are various warning stickers affixed to your bus. These are intended to make you and others aware of various dangers. Therefore, do not remove any warning stickers unless it is expressly stated on the sticker that you may do so.



**Danger.**

If you remove warning stickers, this could result in you or other persons failing to recognise dangers. You or others could be injured as a result.

### Navigation and global positioning system

Please follow the instructions below if your bus is fitted with a navigation system:



**Danger.**

Please devote your attention primarily to road and traffic conditions. Do not operate the navigation and positioning system unless the bus is stationary. Please remember that your bus covers 14 m every second when it is only travelling at approximately 30 mph (50 km/h). The navigation system is unable to detect the maximum load-bearing capacity for bridges or the maximum permissible height for driving through underpasses. The driver is responsible for ensuring that bridge load-bearing capacities and max-

## General safety information

imum headroom clearance are not exceeded.

### Operation of the radio and mobile communications equipment

(e.g. telephone, radio, fax machine, etc.)



#### **Danger.**

Please devote your attention primarily to road and traffic conditions. Do not operate the display unit, radio or mobile communications equipment unless the traffic situation permits this to be done safely. Please remember that your bus covers 14 m every second when it is only travelling at approximately 30 mph (50 km/h).



#### **Note:**

According to Section 23, Paragraph 1a of the German road traffic regulations (StVO), the bus driver is not permitted to use a mobile phone or permanently-installed phone in the Federal Republic of Germany if it is necessary to lift up or hold the mobile phone or the handset of the permanently-installed phone.



#### **Danger.**

Please observe the legal requirements for the operation of mobile phones or vehicle phones in each country.

### Operation of mobile phones and radio equipment without an exterior aerial

We advise against making telephone calls in the bus without an exterior aerial as the operation of radio transmission equipment including radio telephones (mobile phones) may result in the malfunction of inadequately shielded medical equipment (cardiac pacemakers).



#### **Note:**

If a mobile phone, radio or fax machine is retrofitted on the bus in a way that does not comply with the EvoBus installation instructions, the operating permit for your bus may be invalidated (EU Directive 95/54/EC).



#### **Note:**

Installed furnished parts (e.g. ticket-printing machine, ticket-validating machine, destination display, etc.) that are still in use in new buses must comply with the technical requirements of EU Directive 72/245 EEC.



#### **Danger.**

Please observe the legal requirements for the operation of mobile phones or vehicle phones in each country.



### Washing the outside of the bus in an automatic vehicle wash

Prior to washing the bus you must check that the roof hatches, driver's window and the doors are closed. Set the heating/ventilation/air-conditioning control to air-recirculation mode (Smog button). Remove any attachment parts that may be fitted (e.g. satellite receiver on the roof) prior to washing.

Remove the exterior mirrors before the bus is washed in an automatic vehicle wash. The exterior mirrors could otherwise be damaged.



M88\_00-0087-71

Disconnect electrical connections (1) on the mirror arms in the case of buses with electrically adjustable or heated exterior mirrors.

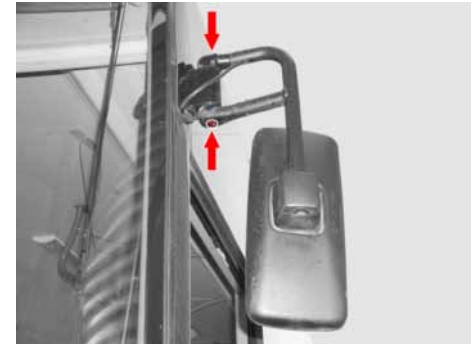

M88\_00-0088-71

Unscrew the securing screws (arrowed) at the bottom and top of the exterior mirror. Remove the mirror arm in the direction of travel.

Fit the exterior mirrors after the bus has been washed.

## Windscreen wiper system safety precautions

### Windscreen wiper system safety precautions

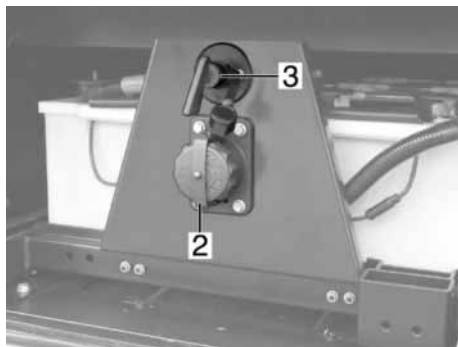

M54\_00-0694-01



### **Danger.**

RISK OF INJURY. Battery isolating switch (3) must always be switched off before any work is carried out on the windscreen wiper system (wiper blade cleaning, replacement of wiper blades or wiper motor etc.).



### **Caution:**

Observe the following if the batteries are to be electrically isolated from the on-board power supply for any reason, e.g. by operation of the battery isolating switch: after switching off the engine, wait at least five minutes before isolating the battery from the on-board power supply. This delay is necessary to ensure fault-free operation of the exhaust gas cleaning system after the bus has been restored to operation.

### Operation of auxiliary heating



### **Danger.**

Risk of fire and burns. There is a risk of fires and burns due to the high exhaust temperatures and the hot exhaust pipe for the auxiliary heating. For this reason, do not stop or park the bus over ignitable materials (e.g. grass) when the auxiliary heating is in operation, has recently been in operation or has been operated by the immediate heating button/preset clock.



### **Danger.**

Risk of poisoning and suffocation. The auxiliary heating must not be used in enclosed spaces such as garages or workshops due to the risk of poisoning and suffocation. It must also not be used in timer or preselection mode.

**Danger.**

Risk of explosion. The auxiliary heating must be switched off at filling stations and fuel dispensing systems due to the risk of explosion.

**Danger.**

Risk of fire. The auxiliary heating must remain switched off in places where ignitable vapours or dust can accumulate (e.g. in the vicinity of filling stations, fuel, coal, sawdust and grain stores or similar).

**Caution:**

The heating unit must be operated for 10 minutes at least once a month (also during the warm season) when the engine is cold.



**Preparation for the journey - daily tasks** ..... 12

**Preparation for the journey - weekly tasks** ..... 13

**General bus care and maintenance** ..... 14

**Care and cleaning** ..... 14

## Preparation for the journey - daily tasks

### Preparation for the journey - daily tasks

- ▶ Check the windscreen washer fluid level and the operation of the windscreen washer system and windscreen wipers.
- ▶ Check the fuel supply for the bus engine and water heater



#### **Danger.**

Switch off the engine and auxiliary heating before refuelling.

- ▶ Check the AdBlue additive reservoir for the BlueTec exhaust gas cleaning system
- ▶ Check the electrical system, paying particular attention to the headlamps, turn signals, tail lamps, brake lamps and licence plate lamps.



#### **Note:**

Under certain weather and operating conditions, moisture may form on the inside of the headlamps and other lights when the bus is stationary. This does not indicate a fault or defect. The ventilation openings in the headlamps allow this moisture to dry off automatically after the bus has been driven for a short time.

- ▶ Check the service covers for secure locking
- ▶ Check the emergency exits
- ▶ Insert the tachograph recording disc or the driver card.



#### **Note:**

The indicator lamp in the tachograph lights up if no disc or driver card has been inserted.

- ▶ Check that the emergency equipment is accessible and complete, e.g. first-aid kit, fire extinguisher, warning triangle, emergency hammer for side windows, jack.

- ▶ Check the adjustment of the rear-view mirrors, clean the mirrors, check the mirror heating for correct function.
- ▶ Check tyre pressures and tyre condition. Check that the wheel nuts are firmly seated.

## Preparation for the journey - weekly tasks

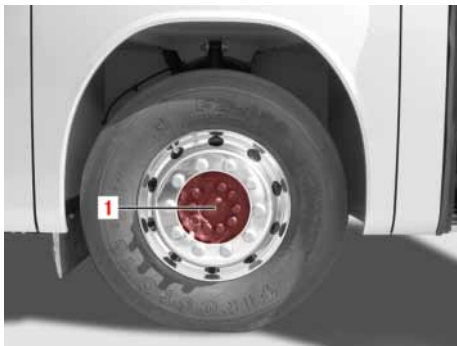

M40\_00-0115-71

- ▶ Check wheel hubs (1) on all wheels for leaks inside and out (visual check).

**Note:**

If the wheel hubs are leaking, there may be grease or oil residue on the tyres themselves or deposits on the parking area under the bus. Consult an EvoBus Service Partner in the event of a leak.

**Preparation for the journey - weekly tasks**

- ▶ Check the oil level in the hydraulic steering system.

**Caution:**

If the oil level is low, have the steering system checked at an authorised specialist workshop.

- ▶ Check the belt tension of all belt drives.
- ▶ Carry out a visual check to ensure there are no leaks in the engine, transmission, driven axle, steering or the cooling and heating systems.
- ▶ Drain the fuel prefilter in the engine compartment.

- ▶ Check the acid level in the starter batteries.

**Danger.**

Observe the safety precautions in the “Practical advice” section.

## General bus care and maintenance

### General bus care and maintenance

- ▶ Carry out the work specified in the Maintenance Record



#### Caution:

Regular maintenance of the chassis and drive train is essential to maintaining the operating safety and roadworthiness of the bus. The time intervals and the scope of work required are specified in the Maintenance Record supplied with the bus.



#### Caution:

It is strongly recommended that the specified maintenance intervals be observed.



#### Note:

Our terms and conditions of sale and delivery do not permit us to recognise claims made under the warranty if the periodic service and maintenance tasks have not been carried out at the specified distances (odometer reading) or times. Have confirmation of the completion of

the work specified in the Maintenance Record recorded by an EvoBus Service Partner.

### Care and cleaning

- ▷ You will find instructions and notes on caring for and cleaning your bus in the “Operation” section.



|   |           |
|---|-----------|
| <b>Running-in guideline</b> .....   | <b>18</b> |
| <b>Starting the engine</b> .....  | <b>18</b> |
| <b>Driving</b> .....  | <b>20</b> |
| <b>Stopping the engine</b> .....  | <b>21</b> |
| <b>Towing</b> .....   | <b>22</b> |
| <b>Front towing coupling</b> .....  | <b>23</b> |
| <b>Rear towing coupling (option, not applicable to Conecto G)</b> .....       | <b>24</b> |
| <b>Brake system safety precautions</b> .....                                  | <b>25</b> |
| <b>Braking and stopping</b> .....   | <b>26</b> |
| <b>Brakes with anti-locking protection</b> .....                              | <b>26</b> |
| <b>Brake pressure/supply pressure (operating pressure)</b> .....              | <b>27</b> |
| <b>Brake system operating/malfunction displays</b> .....                      | <b>28</b> |
| <b>Activating/deactivating acceleration skid control (ASR) (option)</b> ..... | <b>31</b> |
| <b>Operating/malfunction displays ABS/ASR</b> .....                           | <b>31</b> |
| <b>Refuelling (diesel fuel)</b> .....   | <b>33</b> |
| <b>Service products</b> .....   | <b>34</b> |

## Table of contents

|  |           |
|--|-----------|
| <b>BlueTec exhaust gas cleaning system</b> .....   | <b>35</b> |
| <b>AdBlue service product</b> .....  | <b>37</b> |
| <b>Winter operation with diesel fuels for buses with fuel-lubricated injection systems</b> ..... | <b>38</b> |
| <b>Low-temperature characteristics of diesel fuels</b> .....                                     | <b>39</b> |
| <b>Diesel fuels available by region</b> .....  | <b>39</b> |
| <b>Replacing the fuel filter</b> .....   | <b>40</b> |
| <b>Addition of petrol</b> .....  | <b>40</b> |
| <b>Addition of flow improvers</b> .....  | <b>40</b> |
| <b>Measures required in the event of inadequate low-temperature characteristics</b> .....        | <b>41</b> |
| <b>Measures required in the event of pre-existing paraffin separation</b> .....                  | <b>41</b> |
| <b>Winter operation with FAME biodiesel</b> .....  | <b>42</b> |
| <b>Opening/closing the fuel filler cap</b> .....   | <b>42</b> |
| <b>Filling with AdBlue (Euro 4)</b> .....  | <b>44</b> |
| <b>Fuel system operating/malfunction displays</b> .....  | <b>46</b> |
| <b>Anti-jackknifing protection during forward travel</b> .....                                   | <b>47</b> |
| <b>Anti-jackknifing protection during reverse travel</b> .....                                   | <b>48</b> |

**Stop request . . . . . 49**

**Ramp request . . . . . 50**

**Safety instructions for the operation of folding/cassette ramps (option) . . . . . 51**

**Folding the ramp in/out . . . . . 52**

**Retracting/extending the ramp . . . . . 54**

**Opening the hinged window . . . . . 56**

**Care and cleaning . . . . . 57**

**Tilting the rear seats . . . . . 58**

**Tilting seats . . . . . 59**

**Care and cleaning of covers and upholstery . . . . . 59**

**Care/cleaning of fabric covers . . . . . 60**

**Care/cleaning of micro-fibre covers . . . . . 61**

**Care/cleaning of leather covers . . . . . 63**

## Running-in guideline

### Running-in guideline

- ▶ Running in the chassis and drive train



#### Note:

The way in which the chassis and drive train of the new bus are treated during the first 3,000 miles (5,000 km) is critical to the bus' future performance and service life.



#### Note:

The load to which the bus is subjected during this period should be increased only gradually. The maintenance and lubrication tasks specified in the Maintenance Record should be carried out conscientiously.



#### Caution:

Do not place the engine under full load during the running-in period. Up to 1,200 miles (2,000 km): run in with care. Drive at no higher than 3/4 of the maximum rpm in each gear. After 1,200 miles (2,000 km): slowly increase to the

economic rpm in each gear. During the running-in period, do not drive the bus for long distances at the same road speed = same rpm. Varying engine speeds and therefore varying loads demanded of the entire drive train are favourable to the running-in of the bus.

### Starting the engine



#### Note:

Precondition: parking brake applied, transmission in neutral position, electrical system on.



#### Note:

At outside temperatures of below -20 °C, preheat the engine with the water heater (refer to “Heating/ventilation/air-conditioning control panel”).

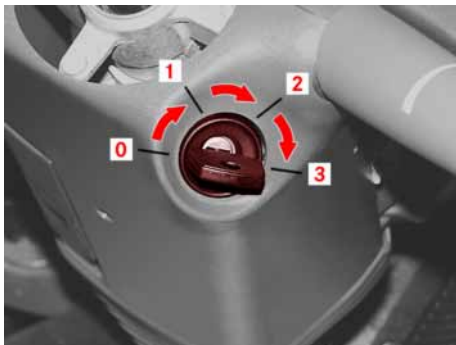

M54.00-0083-01

- ▶ Turn the key to drive position (2).



M54.00-0174-01

Operating displays are displayed one after the other during initialisation of electrical systems.



### Note:

Before starting the engine, wait until the electrical systems have been initialised and the “Bus stop” indication display appears on the screen.



### Note:

If the bus is equipped with a cold-start aid (preglow system), this is controlled when the outside temperature is below a specific value. While the preglow system is active, this symbol  is displayed on the screen for approximately 10 seconds. At the end of this period, the symbol disappears and a signal sounds.

The engine can be started.

- ▶ Turn the key to starting position (3). Do not depress the accelerator pedal. Release the key as soon as the engine starts.

The engine starts.



### Note:

Depress the accelerator pedal slowly if the engine does not start after approximately 5 seconds. – If necessary, interrupt the starting procedure after a maximum of 15 seconds, wait approximately 1 minute, and try again. – Turn the key back to its initial position (0) before the next starting attempt. – Introduce a

## Driving

pause (approximately 15 minutes) after three starting attempts. – Release the key after the engine has started. – Release the accelerator pedal. – Observe the indicator lamps immediately after the engine has started. – If no malfunction is indicated, it is possible to pull away.



### Danger.

Never lock the steering while the bus is in motion. Whenever you disembark, even for a short time, always remove the key so that the bus cannot be started by children or other unauthorised persons.



### Caution:

It is not permitted to increase the engine speed while the “Oil pressure too low” symbol is shown on the display screen. If the “Oil pressure too low” symbol appears for more than 10 seconds, turn off the engine immediately and establish the cause.

## Driving



### Environmental protection

Never warm up the engine while the bus is stationary. Instead, drive off and run the engine at moderate speeds.



### Note:

The engine should not be placed under full load until it has reached normal operating temperature (75 °C - 90 °C depending on operating conditions and the outside temperature).



### Danger.

All doors must be unlocked before the bus is driven off.



### Danger.

The freedom of movement of the pedals must not be restricted. The operating safety and roadworthiness of the bus would otherwise be at risk. Objects could fall and get caught between the pedals if you were to accelerate or brake suddenly, with the result that you would no longer be able to brake, depress the clutch pedal or accelerate. You could cause an accident and put yourself and other people in danger.

- ▶ Check the freedom of movement of the pedals



### Danger.

Where floor mats and carpets are fitted, ensure that they are safely secured against slipping and that there is sufficient space for the pedals.



### Danger.

Do not put any objects in the driver's footwell.



### Danger.

Stow and secure all loose objects in such a way that they cannot get into the driver's footwell when the bus is in motion.

- Observe the rev counter while driving.



### Note:

Keep within the economical operating range. Make sure that the engine speed does not enter the danger zone (red zone).



### Danger.

Test the function of the service brake immediately after pulling away.

### Stopping the engine

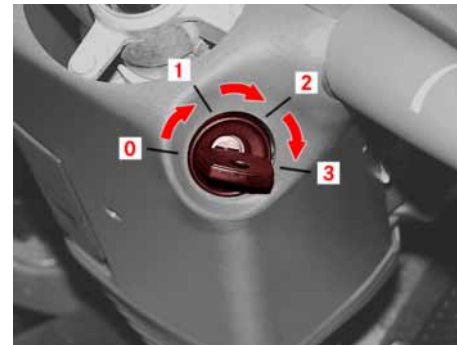

M54.00-0083-01

- Stop the bus - Shift the transmission into neutral - Apply the parking brake. Turn the ignition switch from position 2 (drive position) back to position 1.

## Towing



### Danger.

There is a risk of fire and burns due to the high exhaust temperatures and the hot exhaust pipe for the auxiliary heating. For this reason, make sure when stopping the bus that there is no ignitable material (e.g. dry grass, leaves, etc.) in the area around the exhaust system, the engine and the auxiliary heating exhaust system.



### Note:

Before you switch off the engine, allow it to continue running at idling speed for approximately 1-2 minutes (to allow the exhaust turbochargers to cool down if the coolant temperature is high or if you have been driving at full engine output (e.g. on hilly roads)).

## Towing



### Danger.

Only authorised specialists (recovery service) are permitted to tow away broken-down buses. Observe the legal requirements in all countries concerned.



### Danger.

The ignition switch of the vehicle being towed must always be in position 1. The steering lock must not be engaged. Failure to comply with this guideline could result in the steering locking.



### Caution:

Special measures are required in order to protect the transmission if the bus is to be towed: for safety reasons the propeller shaft must always be removed. The propeller shaft securing screws at the axle flange must be removed and those at the transmission flange secured against displacement.



### Note:

Use a rigid tow bar to tow the bus.



### Note:

The front flap must be closed for the duration of the towing procedure.



### Note:

The towing coupling is suitable for towing vehicles having a gross weight of no more than 18 tonnes.



### Note:

The towing coupling may not be used for trailers.



## Front towing coupling

- ▶ Towing with a raised front axle



### Danger.

The ignition switch must not be switched to position 2 while the front axle is raised. The wheels on the driven axle may lock. Failure to comply could result in brake intervention by the ABS/ASR system, which could cause the rear axle to skid.

### Front towing coupling

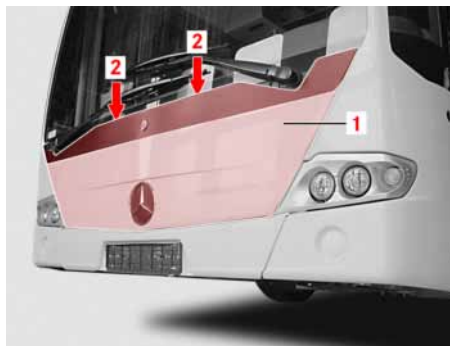

M88\_00-0093-71

- ▶ Grasp handle recesses (2) with both hands and open front flap (1).

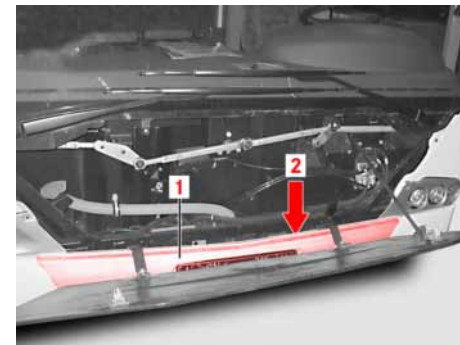

M88\_00-0094-71

- ▶ Release the clip securing the towing coupling and pull out linchpin (2). Remove the lower section of front flap (1) in the direction of travel.

### Rear towing coupling (option, not applicable to Conecto G)

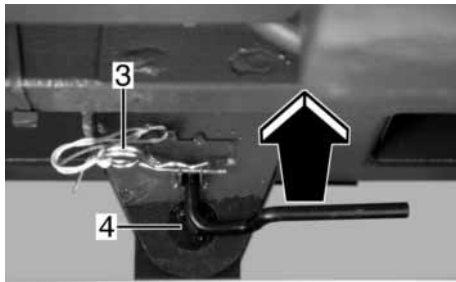

M88\_00-0062-01

- ▶ Fit the eyelet of the tow bar into the towing coupling.
- ▶ Insert linchpin (4) first, then securing clip (3).



#### Note:

Securing clip (3) must be inserted at all times.

Close the upper section of the front flap again.

### Rear towing coupling (option, not applicable to Conecto G)

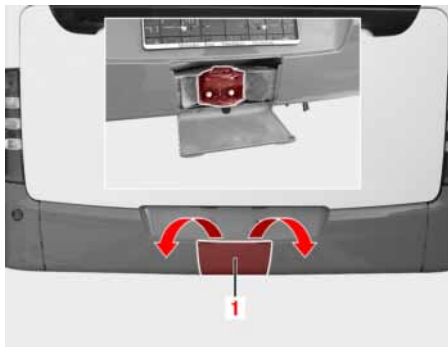

M00\_00-0492-71

- ▶ Remove cover (1).
- ▶ Remove linchpin (5) from the towing coupling.
- ▶ Align the eye on the rigid tow bar.

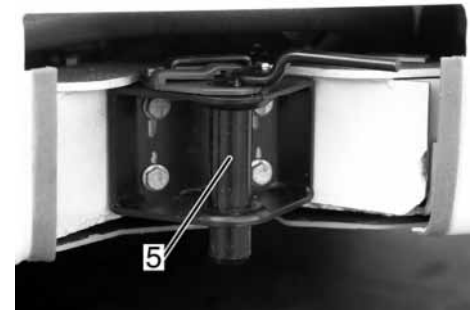

M88\_00-0059-01

- ▶ Insert linchpin (5).

## Brake system safety precautions

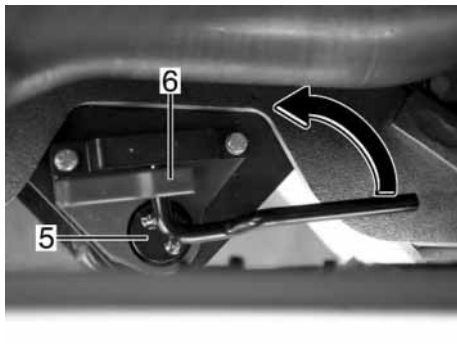

M88\_00-0061-01

- ▶ Turn linchpin (5) anti-clockwise until locking tab (6) engages.



### Note:

Linchpin (5) must be engaged in locking tab (6) at all times.

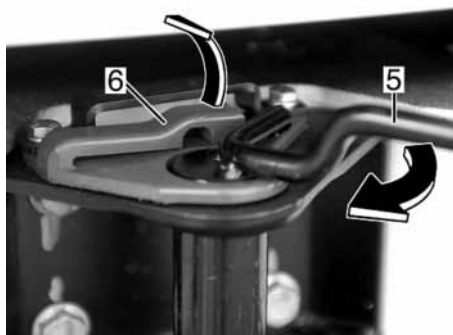

M88\_00-0060-01

- ▶ At the end of towing, lift locking tab (6) slightly and turn the linchpin (5) clockwise until it is released.



### Note:

After towing, reinsert linchpin (5) into the towing coupling and secure.

## Brake system safety precautions



### Caution:

The braking characteristics of the bus may change if a yellow warning level malfunction in the brake system is displayed on the screen in the instrument cluster. Drive with extreme care. Have the fault rectified as soon as possible by an EvoBus Service Partner.



### Danger.

The braking characteristics of the bus have changed if a red warning level malfunction in the brake system is displayed. Pedal travel may increase under braking. ABS is switched off. Stop the bus immediately and disable it (traffic conditions permitting). Have an EvoBus Service Partner rectify the fault immediately.

## Braking and stopping

### Braking and stopping

- ▶ When the bus is driven over long downhill stretches, you should make use of the braking effect of the engine by shifting into a lower gear. Use the integrated retarder in accordance with the manufacturer's operating instructions to relieve the service brake of load.



#### Note:

Except for emergencies, the service brake does not usually need to be applied sharply.



#### Danger.

Always apply the parking brake before you disembark the bus. On uphill or downhill gradients, you must also place wheel chocks at the wheels and turn the steering towards the kerb.

- ▶ Switch off the engine using the ignition switch.

### Brakes with anti-locking protection

- ▶ In the event of danger, the brake pedal should be fully depressed. This guarantees that all wheels are regulated and the bus decelerates optimally.
- ▶ On a slippery road surface, you should also declutch so that the braking effect of the engine cannot affect the ABS control intervention.



#### Note:

The retarder is automatically deactivated for the duration of an ABS control intervention.



#### Danger.

The anti-locking protection of ABS does not relieve the driver of the responsibility for adopting a driving style which takes traffic and road conditions into account. The directional stability and steerability of the bus are improved under braking. However, the anti-locking protection is unable to avert the consequences of driv-

Brake pressure/supply pressure (operating pressure)

ing at unsafe distances from the vehicle in front or at too high a speed around bends.



**Danger.**

If the bus is towing a trailer that does not have ABS, this trailer could be overbraked if the brakes are applied with maximum force. In this event, the driver must keep the trailer in view by checking the rear-view mirror. The bus equipped with ABS remains steerable, thereby enabling the driver to keep the vehicle combination stable.

Brake pressure/supply pressure (operating pressure)



**Note:**

Precondition: minimum operating pressure of 5.5 bar, “Brake pressure/supply pressure” display selected.



**Danger.**

Risk of accident. A supply pressure of at least 6.8 bar in the individual compressed-air circuits is required to ensure the operating safety of the bus. A leaking compressed-air brake system jeopardises the operating safety and roadworthiness of the bus. Stop immediately (traffic conditions permitting) if the supply pressure in the brake system is too low. Have the brake system checked at an EvoBus Service Partner.

- ▶ Apply the service brake.



M54\_00-1162-71

The following is shown on the screen: “Brake pressure” (A) in brake circuit 1 and 2 if the service brake is applied.



**Note:**

The brake pressure is approximately 9 bar when the service brake is fully applied.

- ▶ Release the service brake.

## Brake system operating/malfunction displays

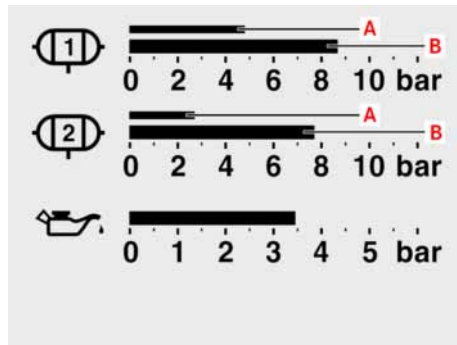

M54\_00-1162-71

The following is shown on the screen:  
Available supply pressure (B) in brake circuits 1 and 2.



### Note:

Supply pressure (B) for brake circuits 1 and 2 is a maximum of approximately 10 bar.



### Note:

If the supply pressure falls below 6.8 bar, the “Brake pressure/supply pressure” display is automatically displayed on the screen and the warning lamp for the yellow warning level lights up.

## Brake system operating/malfunction displays

### “Parking brake applied” indication display (A)

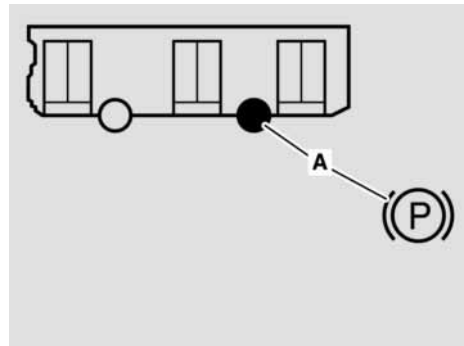

M54.00-0232-01

Brake system operating/malfunction displays

Bus stop brake/drive-off lock active

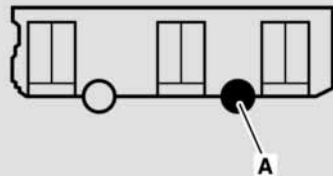

M54.00-0237-01

switch of the bus stop brake has been operated.

“Brake pressure” display

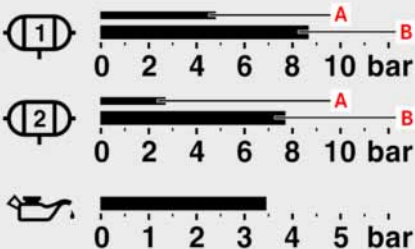

M54\_00-1162-71

The following is shown on the screen: “Brake pressure” (A) in brake circuit 1 and 2 if the service brake is applied.

“Supply pressure” display

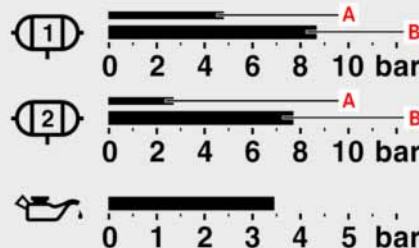

M54\_00-1162-71

The following is shown on the screen: Available supply pressure (B) in brake circuits 1 and 2.

Bus stop brake/drive-off lock malfunction

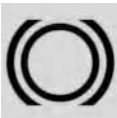

If this symbol is displayed in conjunction with the “Bus stop brake malfunction” message, either the bus stop brake is defective or the emergency release

## Brake system operating/malfunction displays

### Brake pad wear



**Bremsbelag  
zu gering**

M54\_00-1163-01

If the brake pads/linings are too worn, this is indicated on the screen by a service message and a yellow warning level malfunction message.



**Danger.**

The braking characteristics of the bus may change if a yellow warning level malfunction in the brake system is displayed on the screen in the instrument cluster. Drive with extreme care. Have the malfunction rectified as soon as possible by an EvoBus Service Partner.

### Brake pad wear indicator electronics



This icon and a yellow warning level malfunction are displayed if the connection to the electronics system (control unit) of the brake pad wear indicator is malfunctioning or not available.

### Brake pad wear sensor fault (2-axle bus)



This icon appears on the display screen in conjunction with a yellow warning level malfunction if the brake pad wear sensor has a fault.



**Note:**

If the icon does not go out even if you switch the ignition off and on again, have the malfunction rectified by an EvoBus Service Partner.



**Note:**

Example of an icon for a fault on the right-hand side of the driven axle on a 2-axle bus.



## Activating/deactivating acceleration skid control (ASR) (option)

### Activating/deactivating acceleration skid control (ASR) (option)



**Note:**

If traction problems arise when the bus is travelling with anti-skid chains or on routes with loose surfaces (e.g. sand and gravel): deactivate acceleration skid control.



M54\_00-1285-71

- ▶ Press pushbutton (1) with the ignition switched on.



**Danger.**

The bus may skid out of control if ASR is deactivated and the drive wheels start to spin.

- ▶ Pressing pushbutton (1) again or switching the ignition switch off and then back on again reactivates acceleration skid control.

### Operating/malfunction displays ABS/ASR

#### ABS/ASR malfunction



If the ABS/ASR system fails or there is a malfunction, a red or yellow warning level malfunction is shown on the screen depending on the fault level.



**Danger.**

The wheels could lock, especially on a slippery surface - risk of skidding.



**Danger.**

The braking characteristics of the bus may change if a yellow warning level malfunction in the brake system is displayed on the screen in the instrument cluster. Drive with extreme care. Have the fault rectified as soon as possible by an Evo-Bus Service Partner.

### Operating/malfunction displays ABS/ASR



#### **Danger.**

The bus braking characteristics will have changed if a red warning level malfunction is displayed. Pedal travel may increase under braking. ABS is switched off. Stop the bus immediately and disable it (traffic conditions permitting). Have an EvoBus Service Partner rectify the fault immediately.

#### **Acceleration skid control (ASR) active**



ASR is automatically activated if the drive wheels on one or both sides start to spin. An active ASR intervention is shown in the Driving operating display menu on the screen by this icon. If the drive wheels spin on one side, they are automatically braked. - If the drive wheels spin on both sides, engine output will automatically be reduced.



#### **Danger.**

Risk of accident. Acceleration skid control does not relieve the driver of the responsibility for adopting a driving style which takes traffic and road conditions into account.

#### **Deactivating acceleration skid control (ASR)**



Acceleration skid control can be deactivated using the “ASR deactivation” push-button.



#### **Note:**

This icon appears flashing on the instrument cluster display screen.



#### **Danger.**

RISK OF ACCIDENT. The bus could skid if ASR is deactivated and the drive wheels spin.

**Refuelling (diesel fuel)**

Only use diesel fuels that comply with EN 590 (see Specifications for Service Products). Use winter-grade diesel fuel in the cold season (down to approximately -20 °C). If outside temperatures fall even further, the flow properties of the diesel fuel could deteriorate to an unusable level due to paraffin separation. As a preventive measure in this situation, it is permissible to add a specific amount of kerosene or an approved flow improver proportionate to the outside temperature. Engine output may be degraded in line with the amount of additive. The amount of additive should therefore be kept as low as possible under consideration of prevailing outside temperatures. (Maximum kerosene additive 50 %). The addition of kerosene reduces the flash point of the diesel fuel. This therefore increases the dangers involved when working with this fuel mixture. Comply with the relevant safety regulations.

Switch off the engine and auxiliary heating before refuelling. Turn the ignition switch back to position 0. Park the bus on a level surface.

Cleanliness is of utmost importance when refuelling. Do not leave cotton rags or cloths in the vicinity of the open filler neck.

Close the fuel tank properly once filling is complete.

**Danger.**

Risk of injury and explosion. Fuel is highly flammable. Fire, naked flames and smoking are therefore prohibited when fuel is being handled.

**Danger.**

Switch off the auxiliary heating before refuelling to prevent fuel vapour from igniting on the auxiliary heating's exhaust system.

**Danger.**

Fuel is toxic and constitutes a health hazard. For this reason, make sure that the fuel does not come into contact with skin, eyes or clothing, that you do not inhale fuel vapours and that children are kept away from the fuel.

**Danger.**

If you or others have come into contact with fuel: in case of contact with the eyes, rinse them immediately and copiously with clean water and seek medical attention. Clean affected areas of skin immediately with soap and water. Immediately change out of clothing that has come into contact with fuel. If fuel has been swallowed, seek immediate medical attention.



### Environmental protection

Unless they are handled properly, fuels constitute a risk both for people and for the environment. Fuels must not be allowed to enter the sewage system, surface water, ground water or soil.

### Service products

Service products are: fuels, lubricants (e.g. engine oils, transmission oils, greases), coolants, brake fluids, etc. Structural parts and service products must be matched to each other. For this reason, only brands that have been approved by EvoBus are permitted to be used. These are stipulated in the EvoBus Specifications for Service Products.



### Danger.

Risk of injury. Service products can cause damage to health. Contact a doctor immediately if someone has swallowed a service product. Avoid inhaling fumes where possible. Do not allow service products to come into contact with skin, eyes or clothing. Clean any affected areas with water and soap. Rinse eyes thoroughly with clean water in case of contact. Change out of contaminated clothing immediately. Keep service products away from children.



### Environmental protection

Incorrect handling of service products may endanger human life and the environment. Service products must not be allowed to enter the sewage system, surface water, ground water or soil. Dispose of service products and containers and components that have come into contact with service products (e.g. filters) in an environmentally responsible manner. Comply with legal requirements.



### Caution:

Biodiesel (FAME) may only be used as an alternative to diesel fuel on buses that have been approved for operation with biodiesel (FAME) ex works (customer option/code) or as a result of a conversion measure.

**Caution:**

The biodiesel (FAME) used must comply with EN 14214. The use of pure vegetable oils is not permitted.

### BlueTec exhaust gas cleaning system

The BlueTec exhaust gas cleaning system essentially comprises a tank, catalytic converter and AdBlue metering system. It is electronically monitored and controlled. Pollutants in the exhaust gas are converted into environmentally-friendly substances by the addition of AdBlue and the catalytic converter integrated into the silencer.

The BlueTec exhaust gas cleaning system must be operated with a reducing agent (AdBlue) for it to work correctly. Filling with AdBlue is not part of the scope of maintenance jobs and must be done by the operating personnel regularly during operation of the vehicle. Filling and operating the bus with AdBlue is mandatory for compliance with emission regulations and thus one of the conditions for the road traffic approval of the bus. The road traffic approval of the bus will be invalidated if the bus is operated without AdBlue. The legal consequence would be that the bus would no longer

be permitted to be operated on public roads. In some countries, operating the bus without AdBlue may incur a fine or be considered a misdemeanour. Support in the purchase or operation of the bus, e.g. tax relief, road tax, may also be invalidated retrospectively. This may be the case both in the country in which the vehicle is registered and in other countries in which the vehicle is operated.

**Danger.**

It is essential that work relevant to safety or work on safety-related systems be carried out at a qualified specialist workshop.

**Danger.**

Always have maintenance work carried out at a qualified specialist workshop which has the necessary knowledge and tools.

## BlueTec exhaust gas cleaning system



### Caution:

Observe the following if the batteries are to be electrically isolated from the on-board power supply for any reason, e.g. by operation of the battery isolating switch: after switching off the engine, wait at least five minutes before isolating the battery from the on-board power supply. This delay is necessary to ensure fault-free operation of the exhaust gas cleaning system after the bus has been restored to operation.



### Note:

AdBlue freezes at a temperature of approximately  $-11\text{ }^{\circ}\text{C}$ . The bus is equipped with an AdBlue preheating system in the factory. Winter operation is thus ensured, even at temperatures below  $-11\text{ }^{\circ}\text{C}$ .



### Environmental protection

AdBlue is biologically degradable. Unless it is handled properly, AdBlue constitutes an environmental hazard. Do not allow AdBlue to enter the sewage system, surface water, ground water or soil in significant volumes.



### Danger. Risk of poisoning and injury.

AdBlue is not considered a hazardous substance according to German regulations governing hazardous substances. Nevertheless, certain points should be observed when handling AdBlue.

The AdBlue line system and the related system components are pressurised while the engine is warm. There is a risk of scalding from hot AdBlue spraying out if the line system is suddenly opened. There is also the risk of skin irritation or damage to the eyes if AdBlue comes into contact with the skin or eyes.

- Wear protective gloves
- Wear protective clothing
- Wear eye protection

- Work on the exhaust gas aftertreatment system should only be commenced after approximately 4 minutes as individual lines continue to be flushed with compressed air even after the engine has been switched off.
- Turn the ignition switch to the OFF position and remove the key before work is carried out on the SCR system.
- Allow the AdBlue line system to cool down
- Open line connections and system component covers/caps slowly.
- Collect any AdBlue which may escape in a suitable receptacle and dispose of it in an environmentally responsible manner.
- Do not pour AdBlue into drinking containers.
- Wipe up any spilled AdBlue, especially as there is a risk of slipping.
- AdBlue collected in this way must not be poured back into the AdBlue supply tank.

- Rinse affected areas of skin copiously with clean water.
- Quickly change out of clothing that has come into contact with the substance.
- In case of contact with the eyes, rinse them immediately and copiously with clean water and seek medical attention if necessary.
- In cases where AdBlue enters the mouth or is swallowed, rinse the mouth with clean water then drink copious amounts of water.
- Seek medical attention if symptoms persist.

### AdBlue service product

AdBlue is a non-flammable, non-toxic, colourless, odourless, water-soluble liquid.



#### Caution:

Only use AdBlue complying with DIN 70 070. Special additives are not permitted.



#### Caution:

If, during refilling, AdBlue is spilled on painted surfaces or aluminium surfaces, rinse down the surfaces concerned without delay.

### AdBlue and high temperatures



#### Note:

Ammonia vapours can be produced if AdBlue is heated to over 50 °C in the tank for a lengthy period (e.g. as a consequence of direct sunlight).



#### Note:

Ammonia vapours have an acrid odour. For this reason, you must not inhale any ammonia vapours escaping when you remove the AdBlue filler cap. Ammonia vapours are neither poisonous nor hazardous to health in this concentration.

### AdBlue and low temperatures



#### Note:

AdBlue freezes at a temperature of approximately -11 °C. The bus is equipped with an AdBlue preheating system in the factory. Winter operation is thus ensured, even at temperatures below -11 °C.

### AdBlue additives



#### Caution:

Do not add any additives to AdBlue. Do not dilute AdBlue with tap water. This can destroy the exhaust gas cleaning system. Damage to the exhaust gas cleaning system caused by additives or tap water will invalidate the warranty.

## Winter operation with diesel fuels for buses with fuel-lubricated injection systems

### Storage



#### Caution:

Use only containers made from high-alloy CrNi steels or MoCrNi steels complying with EN10088-1/2/3 for the storage of AdBlue. Containers made of copper, alloys containing copper and non-alloy or galvanised steels are not suitable for the storage of AdBlue. If stored in such containers, AdBlue could dissolve out constituents of these metals and destroy the exhaust gas cleaning system. Damage to the exhaust gas cleaning system caused by dissolved out parts of the storage container will invalidate the warranty.

### Disposal of AdBlue



#### Environmental protection

Observe country-specific legislation and requirements governing the disposal of AdBlue.

### AdBlue purity



#### Note:

It is not permitted to return any AdBlue that has been pumped out of the tank, e.g. during a repair, to the tank as the purity of the liquid is no longer guaranteed.

### Winter operation with diesel fuels for buses with fuel-lubricated injection systems

#### WARNING:



#### Danger.

Risk of fire and explosion. Petrol must never be mixed with diesel fuel.



#### Danger.

Risk of fire and explosion. If paraffin has already separated and this has caused operational malfunctions, do not under any circumstances heat components using sources of heat, e.g. heaters, heat radiators, hot air blowers or blow torches. Risk of damage to components. Risk of fuel escaping.



## Low-temperature characteristics of diesel fuels

**Note:**

Please observe the further notes in the text.

▷ Further notes on winter operation with diesel fuel can be found on Mercedes-Benz Specifications for Service Products sheet 137.0.

**Low-temperature characteristics of diesel fuels**

At subzero outside temperatures, the filterability or fluidity (low-temperature characteristics) of diesel fuel could deteriorate as a consequence of paraffin crystal separation.

On average, the temperature values for filterability (low-temperature characteristics) of diesel fuel are 0 °C in the summer, -20 °C in winter and -10 °C in the transition period. During particularly cold spells or if diesel fuel with inadequate low-temperature behaviour is used for refuelling, there is a risk of malfunctions occurring if no precautions are taken to prevent paraffin separation.

**Diesel fuels available by region**

If a cold spell is encountered when driving from warmer to colder regions, it is essential to change over immediately to the diesel fuel conventionally used in the region.

### Replacing the fuel filter

#### Replacing the fuel filter

The fuel filter should be replaced before the onset of winter when diesel fuels with a high water content are used. This avoids the possibility of the fuel filter icing up.

#### Addition of petrol

It is not permitted to add petrol as a flow improver for three reasons:

- Buses with unit pumps could be damaged from lack of lubricant when petrol is added.
- The addition of petrol changes the hazard category for combustible liquids from A III for diesel fuel to A I for petrols. This increases the risk of explosion.
- Petrol has an unfavourable effect upon the starting behaviour of a diesel engine, which may result in considerable starting problems at cold temperatures.



#### **Danger.**

Risk of fire and explosion. Petrol must never be mixed with diesel fuel.

#### Addition of flow improvers

In the case of winter-grade diesel fuels with an operating reliability of  $-20\text{ }^{\circ}\text{C}$  and below, the addition of a flow improver does not promote any further improvement in low-temperature characteristics because these fuels are already saturated with flow improvers.

The following must be taken into account when flow improvers are used:

- Summer diesel fuel: should be added when the fuel temperature is at least  $+8\text{ }^{\circ}\text{C}$ .
- Winter diesel fuel: should be added when the fuel temperature is at least  $0\text{ }^{\circ}\text{C}$ .
- Since diesel fuels vary in their properties, it cannot be guaranteed that every diesel fuel will react positively to the addition of flow improvers. In the case of particularly cold-resistant winter-grade diesel fuels, there could even be a deterioration in low-temperature characteristics. The subsequent addition of flow improvers is not recommended in this instance.

## Measures required in the event of inadequate low-temperature characteristics

## Measures required in the event of inadequate low-temperature characteristics

If no diesel fuel with adequate low-temperature characteristics is available, it is possible to mix the necessary proportion of kerosene with the diesel fuel, preferably before the onset of the cold weather. Each 5 % addition of kerosene by volume improves low-temperature characteristics by approximately 1 °C. The maximum permissible proportion of kerosene in the fuel mixture is 50 % by volume.

**Danger.**

Risk of fire and explosion. For safety reasons, only mix the kerosene with the diesel fuel in the bus fuel tank.

**Danger.**

Risk of fire and explosion. The addition of kerosene reduces the flash point of the diesel fuel. This therefore increases the dangers involved when working with this fuel mixture. Risk of fire and explosion. Comply with the relevant safety regulations.

**Note:**

First add the kerosene to the fuel tank, then the diesel fuel. Then let the engine run for some time so that the fuel mixture is dispersed throughout the whole fuel system.

**Note:**

Engine output may be degraded in line with the amount of additive. The amount of additive should therefore be kept as low as possible under consideration of prevailing outside temperatures.

## Measures required in the event of pre-existing paraffin separation

The addition of flow improvers or kerosene has no effect if paraffin separation has already occurred. Paraffin separation must first be reversed to remedy the situation. This is achieved by heating the entire fuel system.

The fuel system should be heated by parking the bus in a heated indoor facility for a long period. The covers, of the engine compartment for instance, should be opened to accelerate the process.

**Danger.**

Risk of fire and explosion. Do not under any circumstances heat components using artificial sources of heat, e.g. heaters, heat radiators, hot air blowers or blow torches. Risk of damage to components. Risk of fuel escaping. Risk of fire.

### Winter operation with FAME biodiesel

#### Winter operation with FAME biodiesel

DIN EN 14214 demands the following filterability (low-temperature characteristics) temperature limits for FAME:

- 15 Apr to 30 Sep: 0 °C
- 01 Oct to 15 Nov: -10 °C
- 16 Nov to 28 Feb: -20 °C
- 01 Mar to 14 Apr: -10 °C

A fuel preheating system is required if no FAME biodiesel fuel with adequate low-temperature characteristics is available or if lower outside temperatures prevail in the region of use.



#### Note:

Adding flow improvers to the diesel fuel or mixing the diesel fuel with kerosene does not improve the low-temperature characteristics of FAME.



#### Caution:

FAME biodiesel fuels are powerful solvents. For this reason, do not allow these fuels to come into contact with painted bus components.

#### Opening/closing the fuel filler cap

▷ Observe the general information on refuelling.



M88\_00-0067-01

▶ Open the flap (1)

## Opening/closing the fuel filler cap

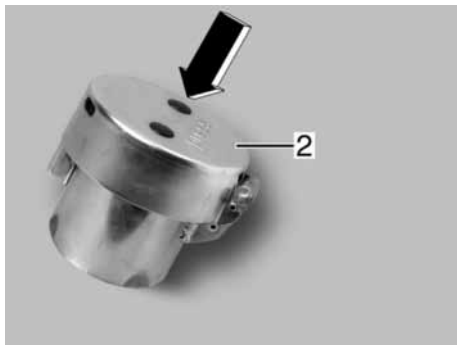

M47\_00-0035-01

- ▶ Push fuel filler cap (2) downwards against the spring pressure.



M47\_00-0036-01

- ▶ Tilt the fuel filler cap.



M47\_00-0037-01

- ▶ Open the fuel filler cap.

### Filling with AdBlue (Euro 4)

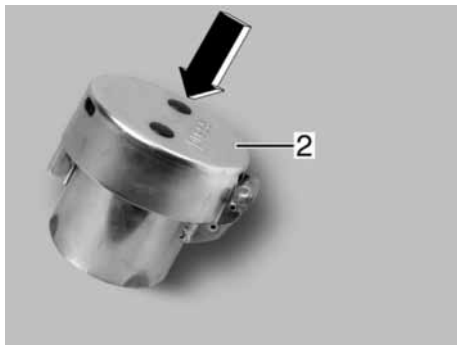

M47\_00-0035-01

- ▶ Push the fuel filler cap (2) downwards until the catch snaps in place.

#### Filling with AdBlue (Euro 4)



##### Note:

An accidental filling of the AdBlue supply tank with diesel fuel and vice versa is prevented by various technical precautionary measures.



##### Note:

AdBlue is consumed at a rate of approximately 5 % of the rate of diesel fuel consumption. It is recommended that the AdBlue supply tank also be refilled at every regular refuelling stop.



##### Caution:

Use only AdBlue compliant with DIN 70 070. Special additives are not permitted.



##### Caution:

If, during refilling, AdBlue is spilled on painted surfaces or aluminium surfaces, rinse down the surfaces concerned without delay.



##### Note:

AdBlue freezes at a temperature of approximately -11 °C. The bus is equipped with an AdBlue preheating system as standard. Winter operation is thus ensured, even at temperatures below -11 °C.

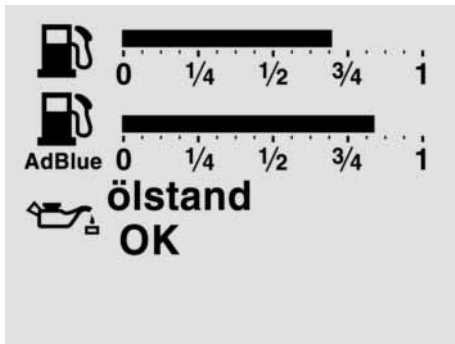

M54\_00-1132-01

- ▶ Reading the AdBlue level



### Note:

Call up this operating display using the display control pushbutton on the instrument panel and read the AdBlue level.

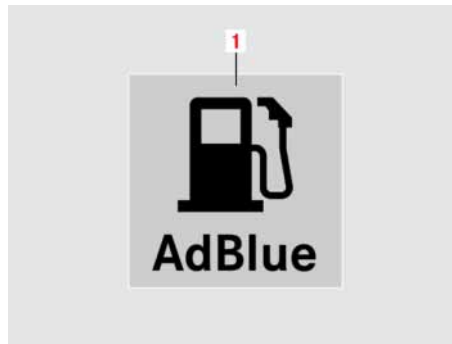

M47\_00-0056-71

- ▶ If the level in the AdBlue supply tank falls to the reserve level, this icon (1) appears on the screen to remind the driver that an AdBlue top-up is due.
- ▶ The driver is informed by an icon on the display screen (see illustration) in conjunction with a yellow level warning message if the AdBlue supply tank runs empty or if there is a malfunction in the BlueTec exhaust gas cleaning system. In this event, it is necessary to top up the AdBlue level immediately or remedy the fault.

- ▶ Filling the tank with AdBlue.



### Note:

The filler opening for the AdBlue supply tank is located to the rear of the front axle (CONNECTO) or to the rear of the articulation (CONNECTO G) on the right-hand side when viewed in the direction of travel.



### Note:

An accidental filling of the AdBlue supply tank with diesel fuel and vice versa is prevented by various technical precautionary measures.

## Fuel system operating/malfunction displays

### Fuel system operating/malfunction displays

#### Fuel reserve



Fuel level has reached the reserve level.

#### AdBlue level



AdBlue

If the level in the AdBlue supply tank falls to the reserve level, this icon appears on the screen and a yellow warning level malfunction message is displayed to remind the driver that an AdBlue top-up is due.

### Exhaust gas cleaning malfunction



The malfunction indicator lamp lights up in the event of a malfunction in the exhaust gas cleaning system (SCR system).



#### Note:

The indicator lamp is located in the instrument cluster.



#### Danger.

Have the malfunction rectified by an EvoBus Service Partner immediately.

### Fault in the exhaust gas cleaning system



The malfunction indicator lamp flashes in the event of a fault in the exhaust

gas cleaning system (display if permissible NOx values exceeded) or the AdBlue supply tank is empty. If the malfunction message was triggered by the AdBlue supply tank running empty, it is necessary to top up the AdBlue level immediately. If the AdBlue supply tank has run empty, the driver must have actively acknowledged the AdBlue level operating display (see above) at some time previously.



#### Note:

The indicator lamp is located in the instrument cluster.



#### Danger.

Have NOx faults rectified immediately by an EvoBus Service Partner.



## Anti-jackknifing protection during forward travel

## Engine torque reduction



In the event of an NOx fault (display if permissible NOx concentration exceeded), engine torque will be reduced the next time the bus moves off from stationary. In this situation, a fault is present in the exhaust gas cleaning system, i.e. the malfunction indicator lamp flashes. If the fault was caused by the AdBlue supply tank running empty, the AdBlue level operating display (see above) is also displayed. The AdBlue supply tank must be filled immediately.

**Note:**

The icon displayed on the screen and the yellow warning level A malfunction display are accompanied by the “Exhaust system engine output reduced” message.

**Danger.**

Have NOx faults rectified immediately by an EvoBus Service Partner.

## Anti-jackknifing protection during forward travel

**Danger.**

Risk of accident. If the rear car begins to swing from side to side, the bus must be stabilised by braking. If a malfunction occurs in the anti-jackknifing protection system (red warning lamp in conjunction with the “Anti-jackknifing protection” symbol), it is permissible to drive the bus as far as the nearest workshop but only in exceptional cases, in favourable weather conditions (non-skid road surface) and at a speed of no more than 12 mph (20 km/h). In all other cases the bus must be towed.

**Note:**

If a malfunction occurs in the anti-jackknifing system, indicated by a red warning lamp in conjunction with the “Anti-jackknifing system malfunction” malfunction display, the vehicle is automatically braked down to a speed of 30 mph (50 km/h).

### Anti-jackknifing protection during reverse travel

- ▶ If the bus articulation angle and steering angle are divergent during forward travel, the anti-jackknifing protection responds as follows.

The buzzer sounds.

Anti-jackknifing protection is activated.



The following is shown on the screen: “Anti-jackknifing protection active”.

- ▶ If the driver countersteers in this situation, the anti-jackknifing protection responds as follows:

Anti-jackknifing protection is deactivated.



The following indication display on the screen goes out: “Anti-jackknifing protection active”.

### Anti-jackknifing protection during reverse travel

- ▶ If the bus articulation turns to a specific angle and reaches a specific speed during reverse travel, the anti-jackknifing protection responds as follows:

The buzzer sounds.

The accelerator pedal is locked.

Anti-jackknifing protection is activated.

The bus stop brake is activated.



M54.00-0241-01

The following is shown on the screen: “Anti-jackknifing protection active” (A) “Bus stop brake active” (B).

- ▶ If the driver countersteers in this situation or presses transmission range “1” to “D”, the anti-jackknifing protection responds as follows:

Anti-jackknifing protection is deactivated.

The following indication display on the screen goes out: “Anti-jackknifing protection active” (A), “Bus stop brake active” (B).

The bus can now be moved forwards again.



### Note:

If a speed of approximately 6 mph (10 km/h) is exceeded when reversing in a straight line, operation of the accelerator pedal is automatically restricted. This prevents further acceleration. If a higher speed is reached despite this measure, the bus stop brake is activated. As soon as the speed falls below 5 mph (9 km/h), the bus stop brake is released and operation of the accelerator pedal is no longer restricted.

### Stop request



### Note:

Precondition: electrical system on, doors closed.

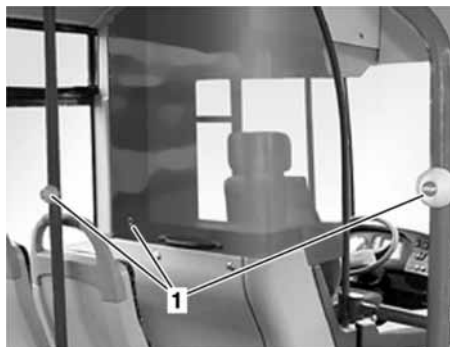

M72.00-0037-01

- ▶ Passenger: press pushbutton (1).  
A signal sounds.



M82.00-0005-01

“Bus stopping” or “Stop” (2) on the passenger information screen lights up.

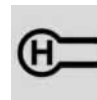

The following is shown on the screen:  
“Stop request” (flashing).

## Ramp request



### Note:

The “Bus stopping” or “Stop” passenger information, and the “Stop request” indication display on the screen, go out when a door is opened.

## Ramp request



### Note:

Precondition: electrical system on.



M72.00-0038-01

- ▶ Passenger: press pushbutton (1).

A signal sounds.



M82.00-0005-01

“Bus stopping” or “Stop” (2) on the passenger information screen lights up.



The “Wheelchair” symbol is displayed on the screen.

Safety instructions for the operation of folding/cassette ramps (option)



**Note:**

Depending on the option, the wheelchair symbol is either a flashing or a static display.



**Note:**

The “Bus stopping” or “Stop” passenger information goes out when a door is opened.



**Note:**

If no ramp is fitted, the “Wheelchair” symbol on the screen goes out after all the doors have closed.



**Note:**

If a ramp is fitted, the “Wheelchair” symbol goes out after the door with the ramp has closed.

Safety instructions for the operation of folding/cassette ramps (option)



**Danger.**

Park the bus in such a way that when the ramp is in operation there can be no possible risk of harm to the person being transported, the operator or other road users.



**Danger.**

The parking brake must be applied.



**Danger.**

Do not exceed the maximum permissible height span.



**Danger.**

Do not fold the ramp out or in (extend or retract it) if anyone is within the ramp's range of movement. Do not subject the ramp to load while it is in motion.



**Danger.**

Observe the maximum payload.



**Note:**

Before the ramp is used, it must be tested for suitability of use, state of repair and possible damage.

▷ For notes on safety and operation, also refer to the manufacturer's operating instructions.

## Folding the ramp in/out

### Folding the ramp in/out



#### Note:

Precondition: bus stationary, door open.



#### Caution:

Observe operating notices and load-bearing capacity plates.

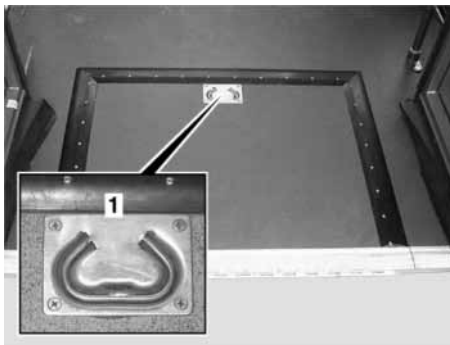

M72.00-0029-01

- ▶ Lift up the ramp from the outside using handle (1) and fold the ramp out.



#### Note:

It is no longer possible to operate the door with the ramp folded out.



#### Danger.

The bus must not be moved while the ramp is in the folded-out position.

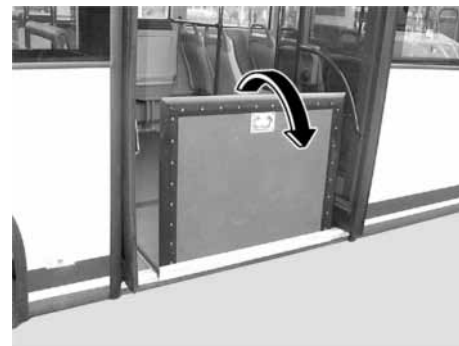

M72.00-0030-01



M72.00-0032-01



### Note:

“Wheelchair” symbol (B) is displayed when the ramp has been requested.

- ▶ The ramp indicator lamp in the instrument cluster lights up.
- ▶ The ramp is folded back in in reverse order.

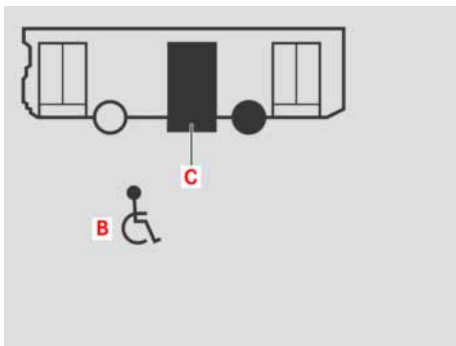

M54\_00-1354-71

The following is shown on the screen: “Ramp folded out” (C).



### Note:

The “Wheelchair” symbol (B) goes out after the door with the ramp has closed.

- ▶ The ramp indicator lamp in the instrument cluster goes out.
- ▶ Ramp malfunction



### Note:

A malfunction is displayed on the screen if the ramp has not been folded in fully but the door is closed.

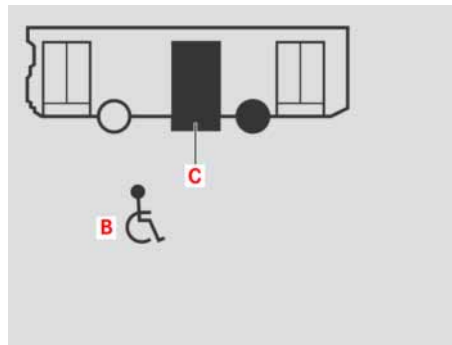

M54\_00-1354-71

The “Ramp folded out” indication display (C) on the screen goes out.

## Retracting/extending the ramp

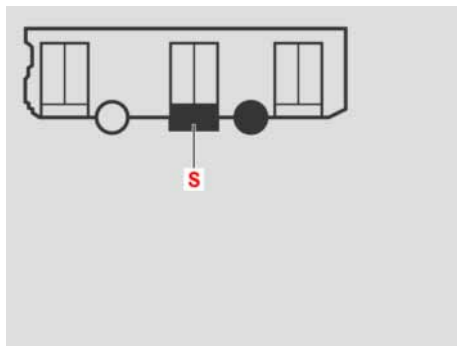

M54\_00-1353-71

The following is shown flashing on the screen: "Ramp malfunction" (S).

### Retracting/extending the ramp



#### Note:

Precondition: bus stationary, door closed.



#### Caution:

Observe operating notices and load-bearing capacity plates.



#### Note:

With the range of options available, there may be a different ramp model installed on the bus and its operating instructions may differ from the instructions provided here.

- ▶ Turn the ramp key switch to position 1



#### Note:

During ramp operation, the bus stop brake remains activated until the ramp is fully retracted.



#### Danger.

The bus must not be moved while the ramp is in the extended position.

- ▶ Press the ramp switch.



#### Note:

Door operation is disabled while the ramp is in use.

The ramp indicator lamp in the instrument cluster lights up.



Retracting/extending the ramp

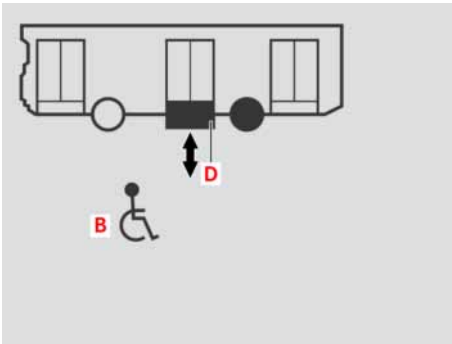

M54\_00-1355-71

The following is shown on the screen:  
 “Ramp in operation” (D), the arrow indicates that the ramp is in motion.



**Danger.**

Risk of entrapment: Make sure that persons or objects are not between the bus body and road surface.



**Caution:**

The ramp retracts if it strikes an obstacle. In this event, manual intervention is necessary to resume ramp operation.



**Note:**

“Wheelchair” symbol (B) is displayed when the ramp has been requested.

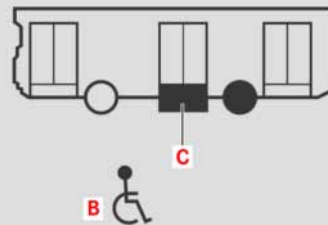

M54\_00-1356-71.tif

Ramp fully extended.



**Note:**

The door can be opened.

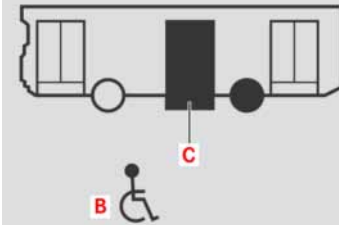

M54\_00-1354-71

Door open

► Retracting the ramp



**Note:**

The ramp retracts automatically after the door has closed.

### Opening the hinged window



**Note:**

“Wheelchair” symbol (B) goes out after the door has closed.



**Note:**

Ramp movement is interrupted if the ramp platform is subjected to load during ramp operation.

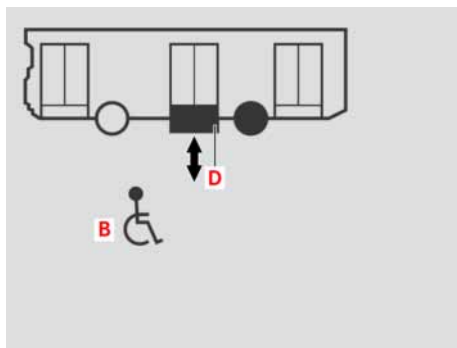

M54\_00-1355-71

The following is shown on the screen: “Ramp in operation” (D), the arrow indicates that the ramp is in motion.

The ramp indicator lamp in the instrument cluster goes out.

The “Ramp extended” indication display (D) on the screen goes out.

### Opening the hinged window



M67.00-0012-01

- ▶ Open the window inwards using the handle.

Air circulates in the passenger compartment without the need for a fan when the hinged windows and roof hatches are open.

## Care and cleaning

**Note:**

Observe the laws and regulations in all countries concerned.

**Danger.**

Risk of injury. Observe the safety regulations when working on the bus (e.g. operational instructions, environmental laws and regulations, work safety and accident prevention regulations, etc.).

**Danger.**

Risk of poisoning. Observe the instructions for use of the care and cleaning products.

**Danger.**

Risk of poisoning. Always keep care and cleaning products sealed and out of the reach of children.

**Danger.**

Risk of poisoning. Diesel, regular and premium-grade fuels constitute a health hazard. They should not be used as a cleaning product.

**Danger.**

Risk of fire. Diesel, regular and premium-grade fuels are highly flammable. They should not be used as a cleaning product.

**Danger.**

Do not use round-spray jets to clean tyres or suspension air bags. The pulsating jet of water could cause concealed damage to the tyre substructure or suspension air bags. This damage only becomes notice-



able much later and could cause the tyre or suspension air bag to burst. This could result in you losing control of your bus and causing an accident, thereby injuring yourself and other people.

**Caution:**

We recommend that only tested and approved care products should be used. Information about acceptable care products can be obtained from your EvoBus Service Partner.

**Caution:**

Stone chips and areas of soiling, especially insect remains, bird droppings, tree resins, oils and greases, fuels or tar stains should be removed immediately using approved care products.

## Tilting the rear seats



### Caution:

The bus must be cleaned more frequently in winter to remove salt residues from road gritting.



### Environmental protection

Dispose of empty containers, cleaning cloths and polishing wads in an environmentally responsible manner.

## Tilting the rear seats



### Note:

The rear seats can be tilted forwards to permit cleaning of the rear area.



### Note:

After cleaning, be sure to fold the seat back and re-engage it.

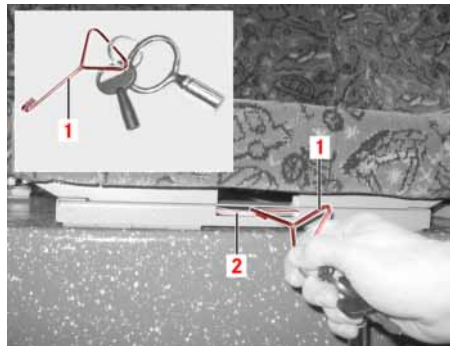

M91\_00-0027-71

- ▶ Use hook key (1) to release the rear seat by pulling cable (2), and fold the rear seat forwards.

It is now possible to clean the area behind the seats.

### Tilting seats



#### Note:

The seats can be tilted forwards to make it possible to clean the area around them and to open the service cover above the transmission.

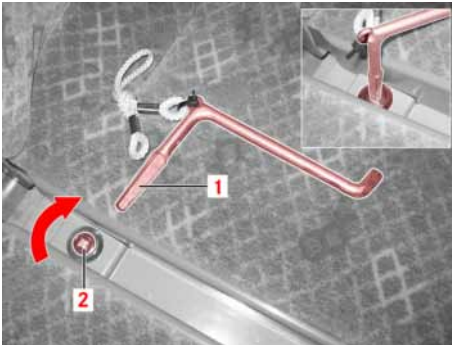

M91\_00-0037-71

- ▶ Using square spanner (1), turn seat release (2) to the right and tilt the seat forward.

It is now possible to clean the area behind the seats. The service cover

above the transmission is now accessible.



#### Note:

Be sure to fold the seat back and re-engage it before commencing a journey.

### Care and cleaning of covers and upholstery

#### Special notes on care and cleaning of covers and upholstery



#### Note:

Observe the instructions on your upholstery fittings and covers in the detailed description of the bus.



#### Caution:

Do not use cleaning products containing solvents (e.g. cleaning benzine, acetone, alcohol, etc.). This would damage covers and equipment parts made of plastic or foam beyond repair.



#### Caution:

Only use pH neutral care and cleaning agents to avoid bleaching out the colours.



## Care/cleaning of fabric covers

### Care/cleaning of fabric covers



#### Danger.

Observe the general information/safety notes in this section.



#### Note:

Regular care and basic cleaning help to maintain the value and high-quality appearance of fabric covers. For this reason, carry out basic cleaning regularly. Carry out basic cleaning more regularly, depending on use and the level of dirt.

### Basic cleaning - weekly

- ▶ Vacuum the covers thoroughly following the nap of the fabric.



#### Caution:

Do not use vacuuming nozzles made of rubber or rubber components. These could pull threads out of the upholstery covers.

- ▶ Brush the fabric with a soft brush following the nap of the fabric.

### Basic cleaning - every six months

- ▶ First carry out the weekly basic cleaning.
- ▶ Make a foam from a mild, lukewarm soap (e.g. from a mild-action detergent).
- ▶ Apply the foam evenly over all the covers using a soft, slightly damp sponge.
- ▶ Wait until the freshly cleaned covers are completely dry.



#### Caution:

The covers must be completely dry before they are used again. Permanent pressure marks could otherwise form.

- ▶ Brush following the nap of the fabric using a soft brush, without applying pressure.

### Removing stains



#### Caution:

Remove dirt as quickly as possible to avoid permanent stains and prevent damage to the covers.

- ▶ Remove as much dirt as possible using a lint-free cloth.
- ▶ Work mild, lukewarm soap into the dirt using a soft sponge in circular movements from the outside in. Apply light pressure when doing this.



#### Note:

Always work on the dirt from the outside in so that the dirt is not spread over the fabric.

- ▶ Remove the soap used using a clean, soft sponge.
- ▶ Wait until the freshly cleaned areas are completely dry.

## Care/cleaning of micro-fibre covers



### Caution:

The covers must be completely dry before they are used again. Permanent pressure marks could otherwise form.

- ▶ Finally, brush the cover and the cleaned areas using a soft brush following the nap of the fabric.



### Caution:

If in any doubt, use a professional textile cleaning company.

## Care/cleaning of micro-fibre covers



### Danger.

Observe the general information/safety notes in this section.



### Note:

Regular care and basic cleaning help to maintain the value and high-quality appearance of micro-fibre and wool covers. For this reason, carry out basic cleaning regularly. Carry out basic cleaning more regularly, depending on use and the level of dirt.

### Basic cleaning - weekly

- ▶ Vacuum the covers following the nap of the fabric, without applying pressure.



### Caution:

Do not use vacuuming nozzles made of rubber or rubber components. These could pull threads out of the upholstery covers.

- ▶ Brush covers following the nap of the fabric using a soft brush, without applying pressure.

### Basic cleaning - every six months

- ▶ First carry out the weekly basic cleaning.
- ▶ Make a foam from a mild, lukewarm soap (e.g. from a mild-action detergent).
- ▶ Apply the foam evenly over all the covers using a soft, slightly damp sponge.
- ▶ Wait until the freshly cleaned covers are completely dry.

## Care/cleaning of micro-fibre covers



### Caution:

The covers must be completely dry before they are used again. Permanent pressure marks could otherwise form.

- ▶ Brush following the nap of the fabric using a soft brush, without applying pressure.

## Removing stains



### Caution:

Remove dirt as quickly as possible to avoid permanent stains and prevent damage to the covers.



### Caution:

Do not use cleaning products containing solvents (e.g. cleaning benzine, acetone, alcohol, etc.). This would damage the micro-fibre covers and equipment parts made of plastic or foam beyond repair.

- ▶ Remove as much dirt as possible using a lint-free cloth.

- ▶ Work mild, lukewarm soap into the dirt using a soft sponge in circular movements from the outside in. Apply light pressure when doing this.



### Note:

Always work on the dirt from the outside in so that the dirt is not spread over the fabric.



### Caution:

Do not use cleaning products containing solvents (e.g. cleaning benzene, acetone, alcohol, etc.). This would damage the micro-fibre covers and equipment parts made of plastic or foam beyond repair.

- ▶ Remove the used soap using a clean, soft sponge.
- ▶ Wait until the freshly cleaned areas are completely dry.



### Caution:

The covers must be completely dry before they are used again. Permanent pressure marks could otherwise form.

- ▶ Finally, brush the cover and the cleaned areas using a soft brush following the nap of the fabric.



### Caution:

If in any doubt, use a professional textile cleaning company.



## Care/cleaning of leather covers

## Care/cleaning of leather covers

**Danger.**

Observe the general information/safety notes in this section.

**Caution:**

Only use distilled water for cleaning to prevent chalky outlines or water marks.

**Caution:**

Avoid direct sunlight to prevent the colours being bleached out.

**Note:**

Regular care and basic cleaning help to maintain the value and high-quality appearance of leather covers, as well as the long-term durability and suppleness of the leather. For this reason, carry out basic cleaning at least four times a year. Carry out basic cleaning more regularly, depending on use and the level of dirt.

## Basic cleaning - every quarter

- ▶ Remove coarse dirt with a very soft brush or a vacuum cleaner.

**Caution:**

Do not use a sharp-edged vacuuming nozzle or a brush which is too hard, otherwise the leather could be irreparably damaged.

- ▶ Moisten a soft, lint-free cloth with distilled water.
- ▶ Wipe leather upholstery down with a damp cloth.

**Caution:**

Do not use a cloth or sponge with a coarse surface, otherwise this could scratch or irreparably damage the leather upholstery.

**Caution:**

Leather upholstery must be dried completely before it is used again, as otherwise permanent pressure marks may form.

## Removing stains

**Caution:**

Remove dirt as quickly as possible to avoid permanent stains and prevent damage to the covers.

- ▶ Remove as much dirt as possible using a soft, lint-free cloth.
- ▶ Work a mild, lukewarm soap gently into the dirty areas.
- ▶ Then wipe the dirt away using a clean cloth.
- ▶ Remove the soap used using clean, distilled water.

### Care/cleaning of leather covers



#### Note:

Any dirt and soap which remains must be completely removed. If in doubt, rinse again.



#### Note:

To prevent outlines forming, a wider area around the mark should always be treated.

- ▶ Then dry the cleaned area with a hairdryer using circular movements at a distance of between 30 and 40 cm on a medium heat setting.



#### Caution:

The leather covers must be completely dry before they are used again. Permanent pressure marks could otherwise form.



#### Caution:

If in any doubt, use a professional leather cleaning company.

### Leather care product



#### Note:

Information about suitable leather care agents can be obtained from your EvoBus Service Partner or from a professional leather cleaning company.

|   |    |
|---|----|
| Overview of vehicle key .....                               | 66 |
| Driver's area overview .....                                | 68 |
| Switches on the left section of the instrument panel .....  | 69 |
| Switches on the right section of the instrument panel ..... | 71 |
| Side panel .....  | 73 |
| Instrument cluster .....                                    | 76 |
| MTCO tachograph .....                                       | 80 |
| DTCO tachograph .....                                       | 82 |
| Tachograph (display) .....                                  | 83 |
| Location of emergency equipment .....                       | 84 |
| Windscreen washer reservoir .....                           | 86 |

## Overview of vehicle key

### Overview of vehicle key



- 1 Key for the ignition switch
- 2 Key for: Doors, interior and exterior flaps
- 3 Key for (option): Doors, interior and exterior flaps
- 4 Key for key switch: Lowering system, ramp, disabled passengers' lift

Driver's area overview

Driver's area overview

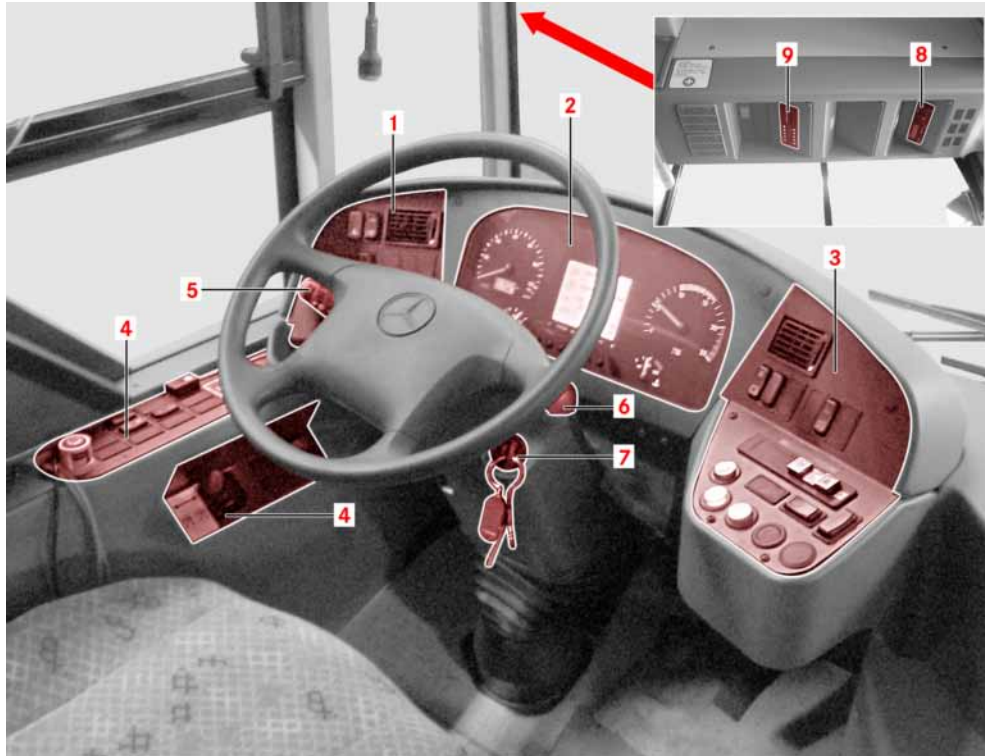

## Switches on the left section of the instrument panel

| No. | Description   | Page |
|-----|---|------|
| 1   | Switches on the left section of the instrument panel              | 69   |
| 2   | Instrument cluster  |      |
| 3   | Switches on the right section of the instrument panel             | 71   |
| 4   | Side panel  | 73   |
| 5   | Steering column switch for light and wiper functions              |      |
| 6   | Steering column switch for retarder and cruise control (overview) | 92   |
| 7   | Ignition switch   | 98   |
| 8   | DTCO tachograph   | 82   |
| 8   | MTCO tachograph   | 80   |

| No. | Description   | Page |
|-----|---|------|
| 9   | Control panel for audio/video system in the driver's area and passenger compartment |      |

## Switches on the left section of the instrument panel

**Note:**

The overview shows the maximum utilisation of the instrument panel with switches and instruments in their designated position. To fulfil customer options, the switches may have been assigned to different positions on the instrument panel or side compartment.

Switches on the left section of the instrument panel





## Switches on the right section of the instrument panel

| No. | Description   | Page |
|-----|---|------|
| 1   | Hazard warning lamps switch                         |      |
| 2   | Pushbutton for raising the bus above normal level   |      |
| 3   | Not assigned  |      |
| 4   | Not assigned  |      |
| 5   | ASR (acceleration skid control) OFF pushbutton      |      |
| 6   | Not assigned  |      |
| 7   | Not assigned  |      |
| 8   | Not assigned  |      |
| 9   | Rotary light switch                                 | 91   |
| 10  | Not assigned  |      |
| 11  | Not assigned  |      |
| 12  | Passenger compartment lighting position I+II switch |      |

| No. | Description                  | Page |
|-----|------------------------------|------|
| 13  | Payment tray lighting switch |      |



## Switches on the right section of the instrument panel

**Note:**

The overview shows the maximum utilisation of the instrument panel with switches and instruments in their designated position. To fulfil customer options, the switches may have been assigned to different positions on the instrument panel.

Switches on the right section of the instrument panel



| No. | Description  | Page |
|-----|--|------|
| 14  |  Display control pushbutton                 |      |
| 15  | Ramp enable switch   |      |
| 16  | Not assigned   |      |
| 17  | Not assigned   |      |
| 18  |  Raise/lower (kneeling) pushbutton (option) |      |
| 19  | Not assigned   |      |
| 20  | Pushbutton switches for gear ranges  |      |
| 21  |  Switch for school bus operation (option)   |      |
| 22  | Door release switch  |      |

| No. | Description  | Page |
|-----|--|------|
| 23  | Bus stop brake pushbutton (option)                             |      |
| 24  | Pushbutton for opening/closing the forward door leaf of door 1 |      |
| 25  | Pushbutton for opening/closing the rear door leaf of door 1    |      |
| 26  | Pushbutton for opening/closing door 2                          |      |
| 27  | Pushbutton for opening/closing door 3                          |      |
| 28  | Pushbutton for opening/closing door 4                          |      |

## Side panel

**Note:**

The overview shows the maximum utilisation of the instrument panel with switches and instruments in their designated position. Switches can be assigned to another position on the instrument panel if this has been specified in the order.



| No. | Description  | Page |
|-----|--|------|
| 1   | Not assigned   |      |
| 2   | Engine start/stop pushbutton   |      |
| 3   | Not assigned   |      |
| 4   | Not assigned   |      |
| 5   |  Roof hatch switch - ventilation  |      |
| 6   | Not assigned   |      |
| 7   | Driver's window/mirror heating pushbutton (for notes on safety and operation, refer to the "Driver's area controls" section of the Operating Instructions) |      |
| 8   | Pushbutton for manual/automatic fans   |      |

| No. | Description  | Page |
|-----|--|------|
| 9   | Not assigned   |      |
| 10  | Not assigned   |      |
| 11  | Not assigned   |      |
| 12  | Not assigned   |      |
| 13  | Not assigned   |      |
| 14  | Master safety switch (emergency-off switch)                        | 100  |
| 15  | Heating/ventilation/air-conditioning control panel - driver's area | 162  |
| 16  | Ramp/disabled passengers' lift (option)                            |      |
| 17  | Not assigned   |      |
| 18  | Drive-off lock emergency release switch                            |      |

| No. | Description  | Page |
|-----|--|------|
| 19  | Not assigned   |      |
| 20  | Master safety switch (refer to the "Driver's area controls" section of the Operating Instructions) |      |
| 21  | Not assigned   |      |
| 22  | Parking brake operating lever (refer to the "Operation" section of the Operating Instructions)     |      |

### Instrument cluster

#### Instrument cluster



#### **Danger.**

Risk of accident. Stop immediately when Red warning lamp display (4) is shown (traffic conditions permitting). The driving and braking characteristics of the bus may change. Notify an EvoBus Service Partner.



#### **Caution:**

Danger. While it is permitted to drive on carefully if Yellow warning lamp display (5) lights up, the bus should be checked at an EvoBus Service Partner at the earliest opportunity.



#### **Note:**

If a malfunction occurs in the anti-jackknifing system, indicated by a red warning lamp in conjunction with the “Anti-jackknifing system malfunction” malfunction display, the vehicle is automatically braked down to a speed of 30 mph (50 km/h).



Instrument cluster

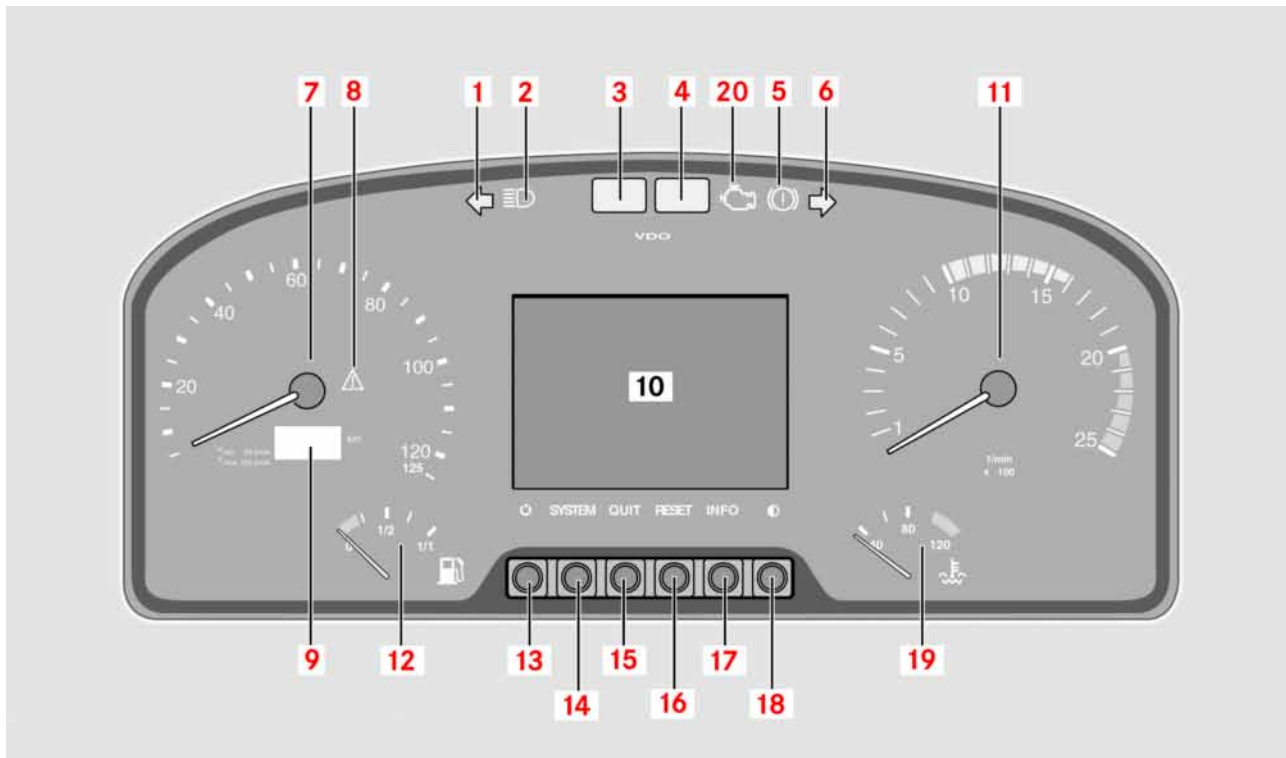



| No. | Description   | Page |
|-----|---|------|
| 1   | Indicator lamp for the left-hand turn signals             |      |
| 2   | Main-beam indicator lamp                                  |      |
| 3   | Red warning level malfunction lamp                        |      |
| 4   | Yellow warning level malfunction lamp                     |      |
| 5   | Parking brake and brake system malfunction indicator lamp |      |
| 6   | Indicator lamp for the right-hand turn signals            |      |
| 7   | Speedometer   |      |
| 8   | Tachograph warning lamp                                   |      |

| No. | Description                                | Page |
|-----|--|------|
| 9   | Total distance reading and clock display   |      |
| 10  | Screen (display)                           |      |
| 11  | Rev counter                                |      |
| 12  | Fuel level gauge                           |      |
| 13  | Selector button for trip meter/time        |      |
| 14  | Button for on-board diagnostics - "System" |      |
| 15  | Button for on-board diagnostics - "Quit"   |      |
| 16  | Button for on-board diagnostics - "Reset"  |      |
| 17  | Button for on-board diagnostics - "Info"   |      |

| No. | Description  | Page |
|-----|--|------|
| 18  | Button for screen brightness                                 |      |
| 19  | Coolant temperature gauge                                    |      |
| 20  | Exhaust gas cleaning system malfunction display (SCR system) |      |

## MTCO tachograph

MTCO tachograph

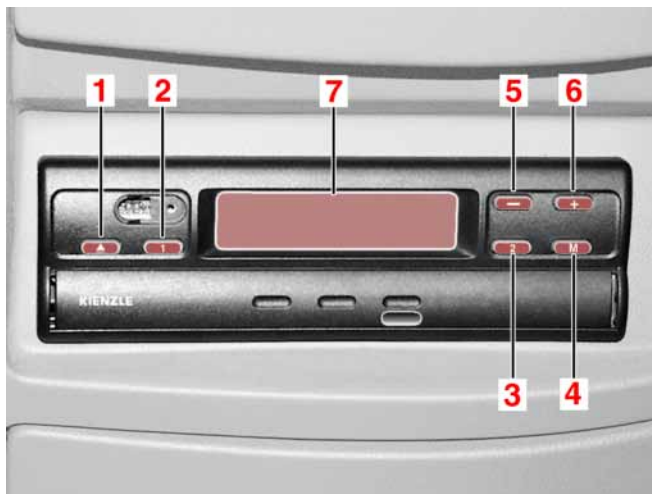

- 1 Button for opening the recording sheet tray: Driver 1 inserts the recording sheet he has labelled with the front side facing upwards onto the partition plate in the recording sheet tray. Driver 2 inserts the recording sheet he has labelled with the front side facing upwards under the partition plate in the recording sheet tray. The recording sheets must be changed over when there is a change of driver.
- 2 Button for setting the required time group for driver 1: Press and hold the button until the required time group appears on the display screen.
- 3 Button for setting the required time group for driver 2: Press and hold the button until the required time group appears on the display screen.
- 4 Menu selection button (clock adjustment, fault indication, etc.): The clock time can be changed at any time. Summer and winter time has been programmed for several years and is automatically changed.
- 5 Button (-): : Moving back within the menu
- 6 Button (+): : Moving forwards within the menu
- 7 Display (lit when ignition switch is switched on): The basic display (date, time and total distance) appears if there are no fault messages. Flashing display = the recording sheet tray time does not correspond to the time on the display screen (e.g. after a voltage supply interruption or changeover from summer to winter time). The time is set automatically: remove the recording sheets and close the recording sheet tray without the recording sheets in it.
  - ▷ Observe the manufacturer's operating instructions.

## DTCO tachograph

### DTCO tachograph

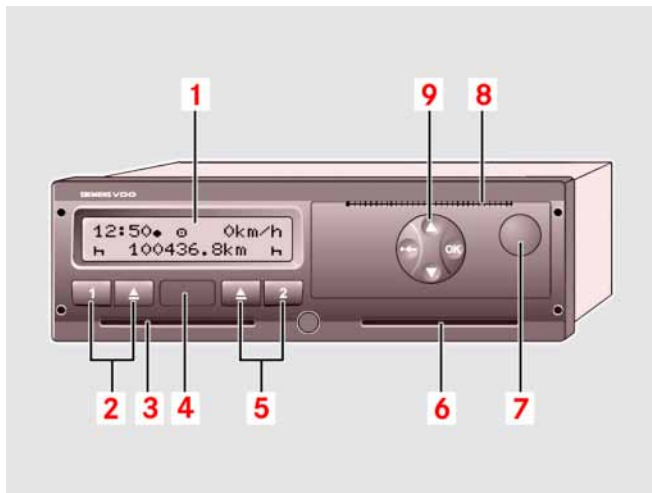

1 Display: Different displays appear depending on the operating state of the bus.

▷ See Display variants in the manufacturer's operating instructions.

2 Key panel, driver 1



**Note:**

Activity button, driver 1/card slot ejector button, driver 1

3 Card slot, driver 1: Driver 1, the current driver of the bus, inserts his driver card into card slot 1.

4 Download/calibration interface: There is an interface under the cover. This interface can only be enabled with an inserted company card, control card or workshop card.

▷ For details, see “Access rights for tachograph cards” in the manufacturer's operating instructions.

5 Key panel, driver 2



**Note:**

Activity button, driver 2/card slot ejector button, driver 2

6 Card slot, driver 2: Driver 2, the current driver of the bus, inserts his driver card into card slot 2.

7 Printer drawer release button: This button is used to release the printer drawer, for example, for inserting a new roll of paper.

8 Tear-off edge

9 Menu buttons: Buttons for entering, displaying or printing data.

▷ See “Calling up menu functions” in the manufacturer's operating instructions.

### Tachograph (display)

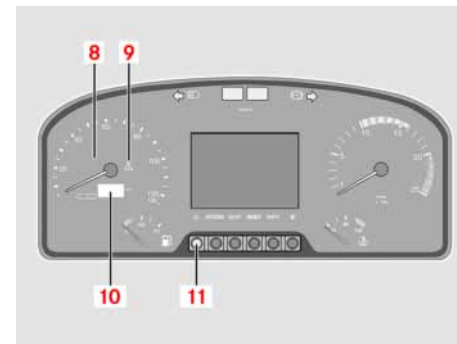

M68\_00-0121-01

### 8 Speed display

### 9 Warning lamp

When lit, this means that there is a message on the tachograph display screen. Driver symbol + fault code = operator error (recording sheet missing or inserted incorrectly or card missing or inserted incorrectly). Fault code = system fault (contact a service centre).

### Location of emergency equipment

10 Display field for total distance recorder, time, trip meter

11 Selection button for time, trip meter

Press this button briefly to change the display (10) between the time and trip meter. Press and hold to reset the trip meter to 0.

### Location of emergency equipment



**Note:**

Observe the laws and regulations in all countries concerned.



**Note:**

The equipment is marked in the specified language.



**Note:**

The markings may differ in colour, design and content, depending on the legislation and specification in the countries concerned.



M86.00-0045-01

- ▶ In an emergency: press in sign (2) and pull out the cover.

Emergency equipment compartment (1) above the driver contains: 2 first-aid kits, 1 warning triangle, 1 warning lamp, 1 windproof flashlight (torch).



**Note:**

Use the key to open emergency equipment compartment (1) in normal circumstances (e.g. to inspect and correct the contents).

**Note:**

Observe the laws and regulations in all countries concerned.



M86.00-0046-01

- ▶ Open snap lock (2) and lift out the fire extinguisher.

Fire extinguisher (1) is ready for operation (observe operating instructions on the fire extinguisher).

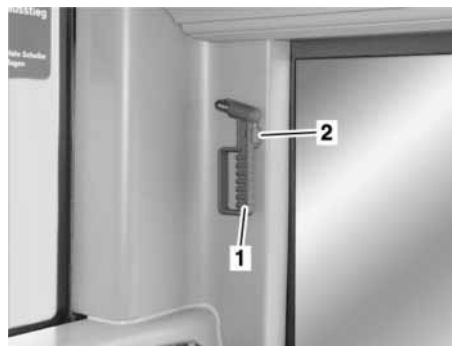

M86.00-0047-01

- ▶ Release emergency hammer (1) (lead seal) and remove it from bracket (2).  
The emergency hammer is ready for operation.

Windscreen washer reservoir

Windscreen washer reservoir

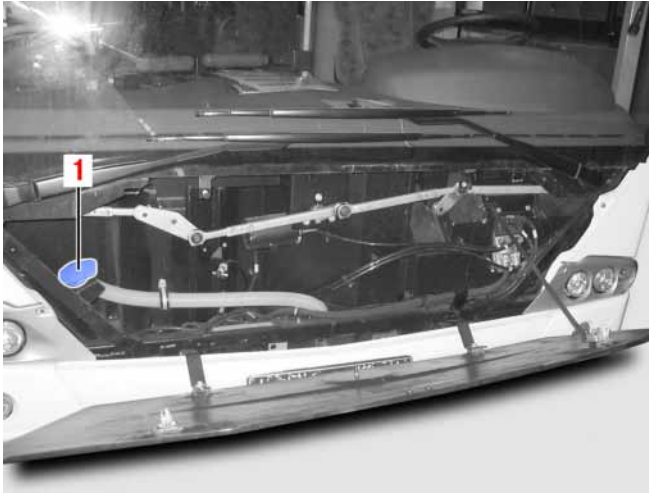



- 1 Windscreen washer reservoir  
filler neck

**Note:**

The windscreen washer fluid reservoir is accessible behind the front flap. With both hands, pull on both handle recesses to open the front flap.

**Note:**

Antifreeze part number A 001  
986 45 71 11



**Rotary light switch** ..... 91

**Steering column switch for light and wiper functions** ..... 92

**Steering column switch for retarder and cruise control (overview)** ..... 92

**Ignition switch** ..... 98

**Parking brake** ..... 99

**Master safety switch (emergency-off switch)** ..... 100

**Screen: description** ..... 101

**Operating displays/driving mode/bus stop mode** ..... 102

**Continuation: bus stop mode** ..... 114

**Malfunction displays: description** ..... 116

**Malfunction displays: red warning level - description** ..... 117

**Malfunction displays: red warning level - overview** ..... 118

**Malfunction displays: yellow warning level A - description** ..... 120

**Malfunction displays: yellow warning level A - overview** ..... 122

**Malfunction displays: yellow warning level B - description** ..... 124

**Malfunction displays: yellow warning level B - overview** ..... 126

### Table of contents

|   |            |
|---|------------|
| <b>Malfunction displays: warning level C - description</b> .....              | <b>127</b> |
| <b>Malfunction displays: warning level C - overview</b> .....                 | <b>128</b> |
| <b>Selecting the language on the screen</b> .....                             | <b>129</b> |
| <b>General Information / Safety Information</b> .....                         | <b>131</b> |
| <b>Lowering/raising the bus on the entry side</b> .....                       | <b>132</b> |
| <b>Raising the bus above normal level</b> .....                               | <b>134</b> |
| <b>Applying the parking brake</b> .....                                       | <b>136</b> |
| <b>Releasing the parking brake</b> .....                                      | <b>137</b> |
| <b>Emergency braking in the event of failure of both brake circuits</b> ..... | <b>138</b> |
| <b>Activating/deactivating the bus stop brake</b> .....                       | <b>139</b> |
| <b>Drive-off lock</b> .....   | <b>140</b> |
| <b>General Information / Safety Information</b> .....                         | <b>141</b> |
| <b>Adjusting the steering column</b> .....                                    | <b>142</b> |
| <b>Turning the steering wheel when the bus is stationary</b> .....            | <b>142</b> |
| <b>Switching the mirror and window heating on and off</b> .....               | <b>143</b> |

### Rotary light switch

combines the following functions:



M54.00-0068-01

- 0 Switched off
- 1 Side lamps
- 2 Headlamps Dipped-beam headlamps/main-beam headlamps (depending on the steering column switch position) with the ignition switch in position 2 (drive position)



#### Note:

In countries where traffic drives on the other side of the road to that in the country where the vehicle was registered, there is a risk of oncoming traffic being dazzled by the asymmetrical dipped-beam headlamps. Observe the country-specific legal requirements when driving in these countries.

- 3 Front foglamps (pull switch 1st position). In addition to the side lamps, dipped-beam headlamps or main-beam headlamps if the ignition switch has been switched to ON

- 4 Rear foglamp (pull switch 2nd position). In addition to the front foglamps. The indicator lamp in the rotary light switch lights up. When a trailer or skibox is connected, the rear foglamp on the towing vehicle is disabled and only the rear foglamp connected via the trailer socket is enabled.

### Steering column switch for light and wiper functions

#### Steering column switch for light and wiper functions

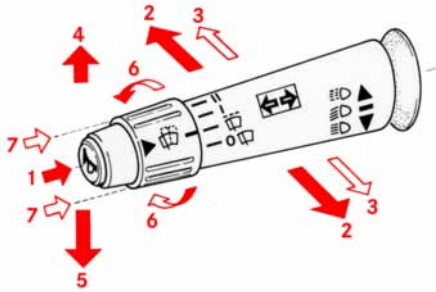

M54.00-0081-01

- 1 Horn: Press button
- 2 Indicate left and right with automatic reset: Push the switch stalk beyond the point of resistance until it clicks into position.
- 3 One-touch indicators for a lane change: Press the switch stalk only briefly (not beyond the pressure point). The turn signals flash five times.

- 4 Headlamp flasher: Pull the stalk upwards
- 5 Main-beam and dipped-beam headlamps: Stalk in basic position = dipped-beam headlamps, stalk down = main-beam headlamps
- 6 Windscreen wipers: Turn the sleeve on the switch stalk: speed 0 = off, speed INT = intermittent, speed I = normal, speed II = rapid
- 7 Wipe and wash: Push sleeve on the switch stalk towards the steering column. With windscreen wipers switched off = windscreen wipe and wash

#### Steering column switch for retarder and cruise control (overview)

#### Combined drive/brake cruise control

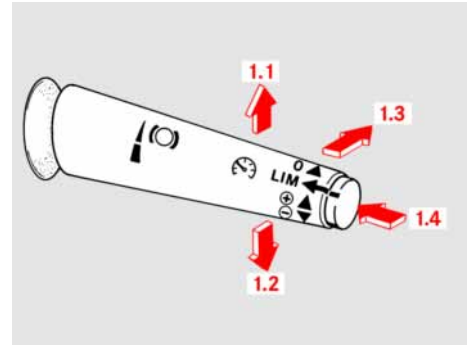

M54\_00-1003-01



#### Note:

Precondition: bus speed must be greater than 10 mph (15 km/h). The clutch and service brake pedals must be fully released and the continuous brakes must not be active.

## Steering column switch for retarder and cruise control (overview)

**Note:**

The speed is maintained constant only for as long as the braking performance of the retarder remains sufficient for this to be possible. If necessary, shift down and reduce speed.

**Note:**

On buses with distance cruise control (ART) (option), this function is automatically activated when combined drive/brake cruise control is activated.

1.1 Tap briefly  
( $< 0.5$  seconds) = current speed is set and shown on the display screen.

**Note:**

Tap briefly again  
( $< 0.5$  seconds) = set speed is increased by 1/3 mph (0.5 km/h).

**Note:**

Press and hold ( $> 0.5$  seconds) = bus speed increased until switch released. When the steering column switch is released, the current speed is set as the new value.

**Note:**

When the distance cruise control is active (option), pressing the switch for longer will increase the target speed by increments of 3 mph (5 km/h). When the combination switch is released, the selected specified speed is set as the new value.

1.2 Tap briefly  
( $< 0.5$  seconds) = current speed is set and shown on the display screen, or resumption of last stored speed.

**Note:**

Tap briefly again  
( $< 0.5$  seconds) = set speed is reduced by 1/3 mph (0.5 km/h).

**Note:**

Press and hold  
( $> 0.5$  seconds) = bus speed reduced until switch released. When the steering column switch is released, the current speed is set as the new value.

**Note:**

When the distance cruise control is active (option), pressing the switch for longer will decrease the target speed by increments of 3 mph (5 km/h). When the combination switch is released, the selected specified speed is set as the new value.

### Steering column switch for retarder and cruise control (overview)

1.3 Cruise control is switched off and the last stored value remains stored in the control unit (until the ignition switch is switched off).



#### Note:

The combined drive/brake cruise control is switched off automatically as soon as the service brake is applied and the cruise control is operational.



#### Note:

If the clutch pedal is depressed, cruise control will remain active when the clutch pedal is subsequently released. However, cruise control will be deactivated if the clutch is depressed for more than 5 seconds. A short signal sounds to indicate that cruise control is in standby mode.

▷ For detailed operating information, refer to “Activating combined drive/brake cruise control” in the “Driving systems” section of the Operating Instructions.

### Variable speed limiter (TempoSet)

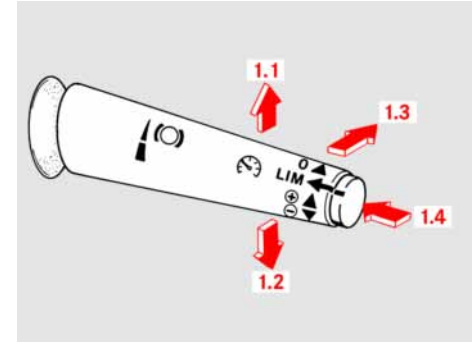

M54\_00-1003-01



## Steering column switch for retarder and cruise control (overview)

1.4 Tap briefly = function changeover to speed limiter (LIM). The function changeover is indicated by the “LIM” symbol on the display screen. If the steering column switch (A) is now moved to position (1.1) or (1.2), the current speed will be set as the limit speed. The set value is shown on the display screen. The driver must continue to use the accelerator pedal.

**Note:**

Press and hold (1.1): the limit speed that was set will be increased by increments of 3 mph (5 km/h) for as long as the switch is pressed.

**Note:**

Press and hold (1.2): the limit speed set will be decreased by increments of 3 mph (5 km/h) for as long as the switch is pressed.

**Note:**

To deactivate: combination switch to position 1.3 or activate cruise control (by pressing button (1.4)).

**Note:**

The speed limiter can be activated at speeds above 6 mph (10 km/h); between 6 mph (10 km/h) and 10 mph (15 km/h) it is always limited to 10 mph (15 km/h). It is possible to exceed the set speed temporarily by depressing the accelerator pedal beyond the stop (kickdown). As soon as the accelerator pedal is released, the stored limit speed will become effective once more.

**Note:**

The retarder is automatically activated if the set limit speed is exceeded by more than 4 km/h in overrun mode.

▷ For detailed operating information, refer to “Activating the variable speed limiter (Temposet)” in the “Driving sys-

### Steering column switch for retarder and cruise control (overview)

tems” section of the Operating Instructions.

#### Distance cruise control (option)

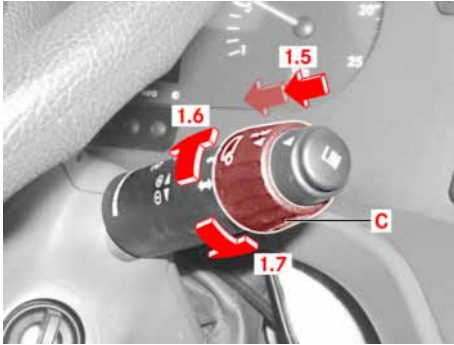

M54\_00-0994-01

1.5 Distance cruise control off/on



#### Note:

On buses with distance cruise control (ART) (option), this function is automatically activated when combined drive/brake cruise control is activated. It can be deactivated and reactivated by operating the sliding sleeve (C) towards the steering column.

1.6 Reducing the specified distance



#### Note:

Operate the sliding sleeve (C) briefly = the specified distance will be displayed



#### Note:

Operate the sliding sleeve (C) for longer = the specified distance will be reduced

1.7 Increasing the specified distance



#### Note:

Operate the sliding sleeve (C) briefly = the specified distance will be displayed



#### Note:

Operate the sliding sleeve (C) for longer = the specified distance will be increased

▷ For detailed operating information, refer to “Activating distance cruise control” in the “Driving systems” section of the Operating Instructions.

Steering column switch for retarder and cruise control (overview)

Continuous braking

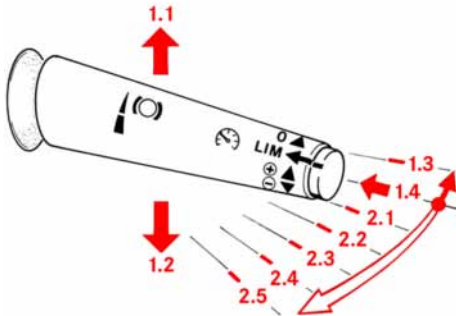

M54.00-0082-01

Activating continuous braking:



**Danger.**

Do not activate the continuous brake (retarder) on a slippery road surface. The wheels could lock - risk of skidding.



**Danger.**

If the accelerator pedal is operated while the continuous brakes are active, the continuous brakes are deactivated and braking output is reduced to zero.



**Caution:**

Always move the combination switch through each of the available stages to achieve the required braking torque (do not move it directly to the required position). It is not permitted to move the combination switch directly to the required position except in an emergency. However, it is acceptable to skip several stages at once if you are reducing the braking torque. For the optimum braking torque to be achieved, the engine should be turning within its upper speed range so that the coolant does not overheat.



**Danger.**

When the ABS system is working correctly, an activated continuous brake is automatically deactivated if one or both of the wheels on the driven axle threatens to lock. If an ABS malfunction message is present, there is no guarantee that this function will be carried out - risk of skidding.

2.1-2.2 Retarder stage 1-2 active

2.3-2.5 Engine brake, constantly open throttle, retarder stages 3 and 4 active



**Note:**

The combined effect of the engine brake and constantly open throttle depends on the braking torque currently available.

## Ignition switch

### Engine speed increase

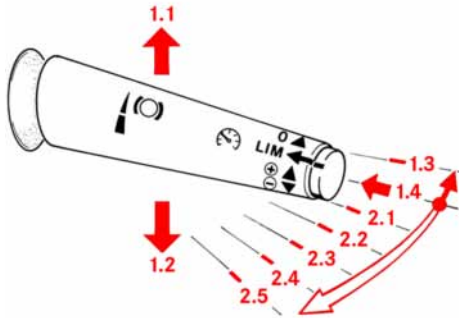

M54.00-0082-01

Precondition: bus stationary, engine running.

1.1 The engine speed can be increased up to a maximum of 750 rpm.

1.3 Engine speed increase off, normal idling speed

### Ignition switch



**Danger.**

Never lock the steering while the bus is in motion. Whenever you disembark, even for a short time, always remove the key so that the bus cannot be started by children or other unauthorised persons.

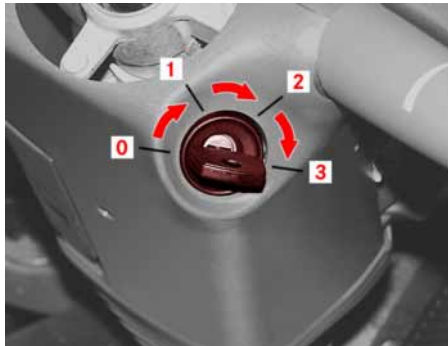

M54.00-0083-01

0 Parked position - Insert or take out the key in this position; the side lamps can be switched on.

- 1 Steering unlocked - All consumers can be switched on.
- 2 Drive position
- 3 Starting position

## Parking brake

### Parking brake valve



#### Caution:

The parking brake spring actuators require a release pressure of 5.8 to 6.4 bar. At low supply pressures, there is a risk that the brake may not be fully released, that the friction pads may make slight contact while the bus is in motion and that the brake may be subjected to unnecessarily high thermal loads. When the parking brake is released, the relevant icon on the screen must go out. If the compressed-air system for the parking brake is damaged, it is possible to release the parking brake using the emergency release device.



#### Caution:

Do not apply the parking brake unless the bus is stationary.



#### Danger.

Always apply the parking brake before you leave the driver's area.



#### Danger.

Check that the hand lever is fully locked in place.



#### Danger.

ABS is inoperative when the parking brake is applied.

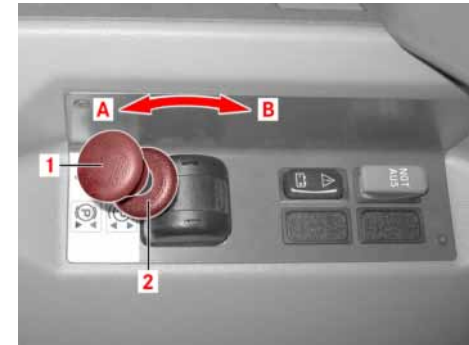

M42\_00-0650-71

▷ For notes on safety and operation, refer to the “Driver's area controls” section of the Operating Instructions.

### Master safety switch (emergency-off switch)

#### Master safety switch (emergency-off switch)

When master safety switch (1) is operated, a running engine is switched off and the power supply for the bus is interrupted. The hazard warning lamps remain functional. Activate the emergency-off switch by pressing the red knob. Unlock the switch by turning the red knob anti-clockwise.



#### Danger.

Risk of accident. The emergency-off switch should not be operated except in an emergency and only with the bus stationary - never while the bus is in motion. Operating the emergency-off switch causes the engine to switch off automatically. The power steering would consequently be disabled if the bus were in motion. Additional effort would then be required in order to steer. Furthermore, the power supply to all important electrical consumers (e.g. bus lighting, ABS, electrical transmission shift system, etc.) would be interrupted. The roadworthiness of the bus is at risk.



#### Note:

There may be additional functions available, depending on the national variant.



#### Note:

In Finland, Greece, Spain and Italy, the hazard warning lamps and interior lighting are switched on automatically. The central locking is ready for operation (ECE-R 36).



#### Note:

In France, the hazard warning lamps are ready for operation.



#### Note:

In Norway, the hazard warning lamps, interior lighting, auxiliary heating (water heater) and horn are ready for operation.



#### Note:

In Poland, the hazard warning lamps are switched on automatically.



#### Note:

In Austria, operating the emergency-off switch switches off the engine and interrupts the supply of power to the entire electrical system.



M54\_00-1309-71

## Screen: description

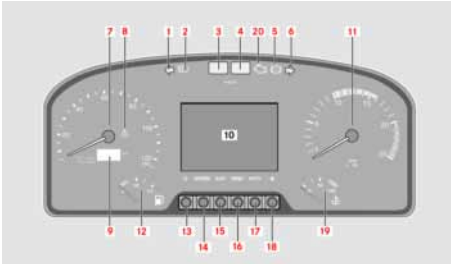

M68\_00-0187-75

Screen (10) is a status indicator for displaying operating and malfunction information. To provide the driver with information in an organised manner, the operating information is divided into three display types: 1.) Operating displays, 2.) Displays in driving mode, 3.) Displays in bus stop mode. For malfunction information, a distinction is made between major and minor malfunctions. Malfunction information is subdivided into four warning levels: 1.) Red warning level, 2.) Yellow warning level A, 3.) Yellow warning level B, 4.) Warning level C. Screen (10) can also be used to display on-board diagnostics information.

Screen (14) is activated when the following functions are switched on: electrical system, door opened from outside, exterior lighting, interior lighting, hazard warning lamps, radio call.

**Note:**

The messages for the operating information and malfunction information are displayed in the language selected

**Note:**

After the electrical system has been switched on, each of the operating displays is displayed automatically in succession.

**Note:**

If the exterior lighting is switched on, screen (10) shows the display in inverse video (highlighted). If a malfunction occurs, this malfunction is displayed only if the key is in the drive position in the ignition switch.

**Note:**

Also displayed is information from the computer-controlled operation management system (option).

### Operating displays/driving mode/bus stop mode

#### Operating displays/driving mode/bus stop mode

To provide the driver with information in an organised manner, the operating information is divided into three display types: 1.) Operating displays, 2.) Displays in driving mode, 3.) Displays in bus stop mode.

#### 1.) Operating displays.



M54\_00-1334-71

After the electrical system has been switched on, each of the operating displays is displayed on the screen once in succession. It is then only possible to call up the operating displays by press-

ing pushbutton (1) on the instrument panel.



#### Danger.

Risk of accident. Calling up additional information while the vehicle is in motion would divert your attention away from the road and traffic conditions. This could result in an accident with serious or fatal injuries. For this reason, do not call up information unless the bus is stationary and the parking brake is applied.



#### Note:

This display mode remains active for approximately 5 seconds. Then, if the parking brake is not applied or if the bus stop brake or drive-off lock is not active, the display mode switches to "Driving mode". If the parking brake is applied or if the bus stop brake or drive-off lock is active, the display mode switches to "Bus stop mode".

#### Splitscreen

The screen is split horizontally into two differently sized areas. The upper area occupies 3/4 of the screen, the lower area 1/4. Both areas can be operated independently using pushbutton (1).



#### Note:

The splitting of the screen is virtual, i.e. there is no visible partition between the two areas. The split is only evident when the upper or lower area is operated independently of the other using pushbutton (1).



### Brake pressure, supply pressure and (engine) oil pressure

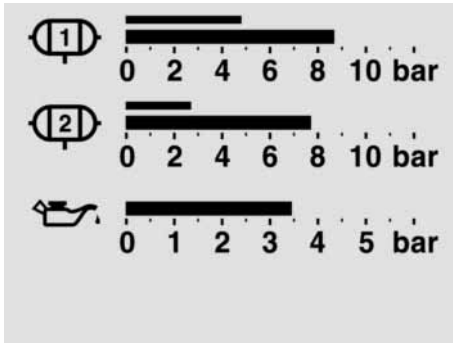

M54\_00-1131-01

The brake pressure and supply pressure for brake circuits one (1) and two (2) are each represented by a bar ranging from 0 to a maximum of 12 bar. The thicker bar represents the supply pressure, the thinner bar the brake pressure of the relevant brake circuit. The current oil pressure of between 0 and 5 bar is displayed below the display for brake circuits one and two.

### Fuel level, AdBlue level and (engine) oil level

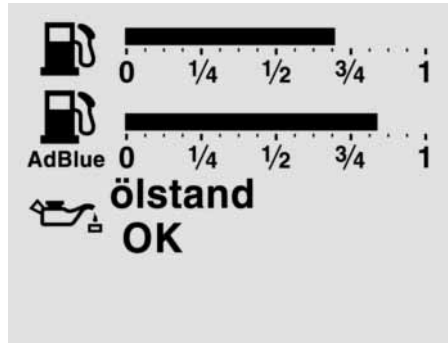

M54\_00-1132-01

The fuel level is represented by a bar ranging from 0 (empty) to 1 (full). The same applies to the AdBlue level. The "Oil level OK" message indicates that the oil level is correct.



#### Note:

If the oil level is correct, it is not possible to call up any further oil level information.



#### Note:

If the oil level is not correct, see the following displays.

### Oil level too low

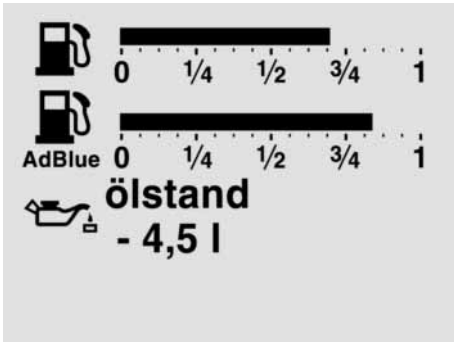

M54\_00-1134-01

An insufficient oil level is indicated by the "Oil level" message and the top-up

### Operating displays/driving mode/bus stop mode

amount required in litres (4.5 litres in the example).



#### Note:

This display is only available if a yellow warning level malfunction or the "Message available" symbol (spanner) has previously been displayed.



#### Caution:

There is a risk of engine damage if the oil level is too low. Therefore, correct the oil level as soon as possible.

#### Oil level too high

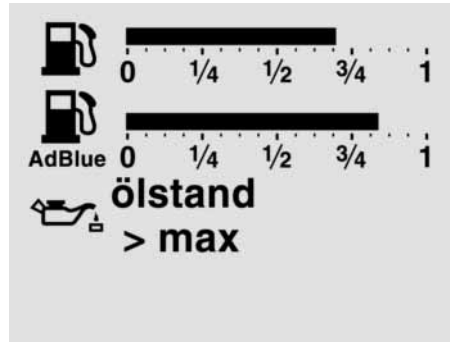

M54\_00-1135-01

The oil level is too high if the "Oil level > max" message is displayed.



#### Note:

This display is only available if a yellow warning level malfunction has previously been displayed.



#### Note:

There is a risk of engine damage if the oil level is too high. Therefore, correct the oil level as soon as possible.

#### Oil level cannot be measured

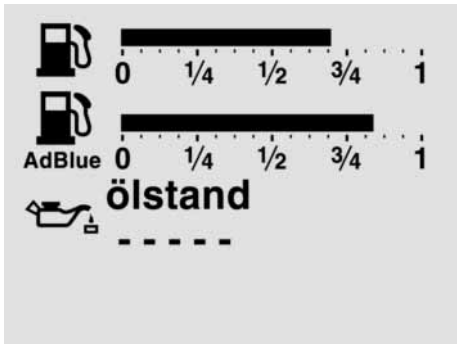

M54\_00-1136-01

The oil level cannot be measured if the "Oil level -----" message is displayed.

Coolant temperature, transmission oil temperature and engine oil temperature

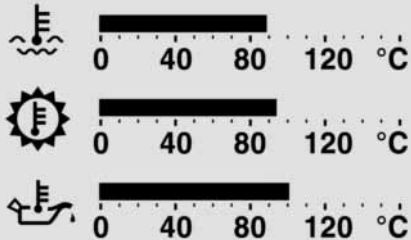

M54\_00-1133-01

The current coolant temperature is represented in the upper area by a bar ranging from 0 °C and a maximum of 160 °C. The display underneath shows the current transmission oil temperature and the bottom display shows the current engine oil temperature.

### 2.) Driving mode displays



M54.00-0173-01

This display mode is active when the vehicle is in motion. It notifies the driver of important system information and indicates when a system is active or when a system is temporarily limited in its operation or scope of functions but no malfunction is present.



**Note:**

Also displayed is information from the computer-controlled operation management system (option).

### Driving mode displays - overview

### Message available



M54\_00-0631-01

### Operating displays/driving mode/bus stop mode



**Caution:**

“Message available” symbol (A) on the screen indicates that it is possible to call up a message (malfunction, maintenance due) from a system.



**Caution:**

If “Message available” symbol (A) is shown permanently on the screen, consult or visit the relevant workshop.

#### Transmission oil too hot



M54\_00-0551-01

Displayed if the oil in the retarder is too hot.



**Caution:**

The braking effect of the retarder is automatically reduced as a function of the operating temperature in order to protect the retarder against damage from overheating when it is in continuous operation. Adapt your driving style accordingly, particularly on long downhill gradients.

#### Retarder active (permanent display)



M54\_00-0561-01

Displayed if the brake pedal is depressed or if the driver operates the retarder manually using the control lever on the steering column.

### Automatic transmission in neutral display



M54\_00-0559-01

Displayed if the “N” pushbutton in the switch panel is pressed and the transmission is in neutral.

### Acceleration skid control deactivated (flashing)



M54\_00-0562-01

Displayed if acceleration skid control has been deactivated using the pushbutton on the instrument panel.

### Acceleration skid control activated (permanent display)



M54\_00-0562-01

Displayed if the drive wheels on one side start to spin and acceleration skid control actively intervenes.



**Danger.**

Risk of accident from spinning drive wheels. The bus may skid if the drive wheels start to spin.



**Danger.**

Risk of accident. Acceleration skid control does not relieve the driver of the responsibility for adopting a driving style which takes traffic and road conditions into account.

### Operating displays/driving mode/bus stop mode

#### Parking brake active (permanent display)



M54\_00-0563-01

Displayed if the parking brake operating lever on the side compartment is applied.



#### **Danger.**

Danger. Do not apply the parking brake unless the bus is stationary. Always apply the parking brake before you disembark. On uphill and downhill gradients, you must also chock the wheels and turn the steering towards the kerb.



#### **Note:**

Danger. Check the hand lever for full engagement. To do so, attempt to press the hand lever in the “release” direction without pulling the release ring out of the detent position. The lever must not move.

#### Bus stop brake active (permanent display)



M54\_00-0564-01

Displayed if the bus stop brake has been activated using the switch on the instrument panel.



#### **Danger.**

Risk of accident. Apply the parking brake before you leave the driver's area. The bus stop brake must not be used to park the bus. Apply the parking brake at bus stops on steep uphill or downhill gradients that exceed 15 %.



#### **Danger.**

Risk of accident. Do not apply the bus stop brake unless the bus is stationary.

## Stop request (flashing)



M54\_00-0575-01

Displayed if a passenger presses a “STOP” pushbutton in the passenger compartment.

## Ramp request (flashing)



M54\_00-0576-01

Displayed if a passenger presses a “Ramp request” pushbutton in the passenger compartment or on the outside of the bus.

## Pushchair (flashing)

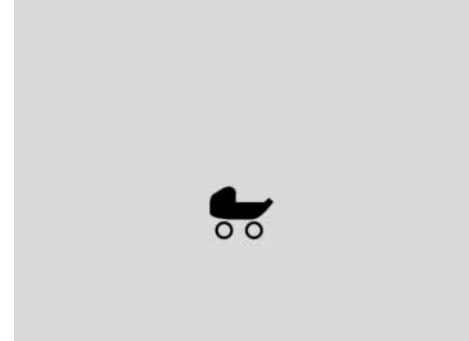

M54\_00-0577-01

Displayed if a passenger presses a “Pushchair” pushbutton in the passenger compartment or on the outside of the bus.

**Note:**

The door is held open if a “Pushchair” pushbutton is pressed.

### Operating displays/driving mode/bus stop mode

#### Bus raised/lowered (permanent display)

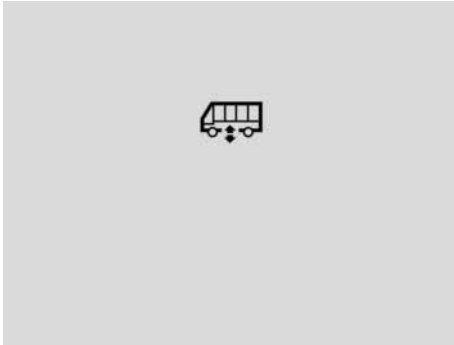

M54\_00-0581-01

Displayed if the bus has been raised or lowered beyond the normal level using the pushbutton on the instrument panel.



#### Note:

For notes on safety and operation, refer to the "Driver's area controls" section of the Operating Instructions.

#### Anti-jackknifing protection active (permanent display)

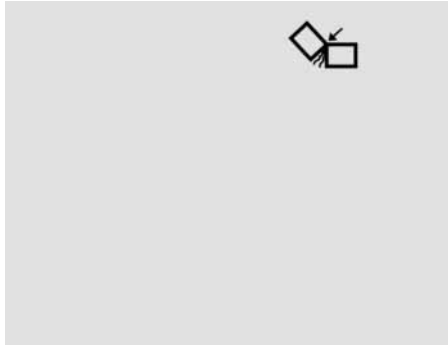

M54\_00-0602-01

Displayed when the anti-jackknifing protection is active during forward travel.



#### Note:

For notes on safety and operation, refer to the "Operation" section of the Operating Instructions.

#### Anti-jackknifing protection active (A) (permanent display), bus stop brake active (B) (permanent display)

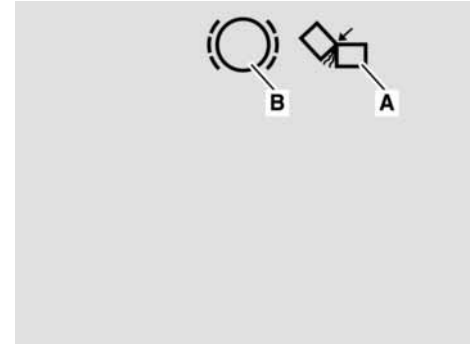

M54.00-0241-01

Displayed when the anti-jackknifing protection is engaged and the bus is being reversed.





### Note:

For notes on safety and operation, refer to the "Operation" section of the Operating Instructions.

### Centralised lubrication (option) active (permanent display)



M54\_00-0604-01

Displayed if the centralised lubrication system initiates (carries out) a lubrication process.

### Auxiliary heating active (permanent display)



M54\_00-0606-01

Displayed if the auxiliary heating has been switched on using the pushbutton in the heating/ventilation/air-conditioning control panel.

### Driver's window and exterior mirror heating active (permanent display)



M54\_00-0607-01

Displayed if the driver's window and exterior mirror heating have been switched on using the pushbutton on the side compartment.



### Note:

Heating for the driver's window and exterior mirror is only active for approximately 12 minutes.

### Operating displays/driving mode/bus stop mode

Windscreen heating (option) active  
(permanent display)



M54\_00-0608-01

Displayed if the windscreen heating has been switched on using the pushbutton on the side compartment.



**Note:**

The heating for the windscreen is only active for approximately 12 minutes.

Air-conditioning system active  
(permanent display)



M54\_00-0609-01

Displayed as soon as the refrigerant compressor is running.

Roof hatches open (permanent display)

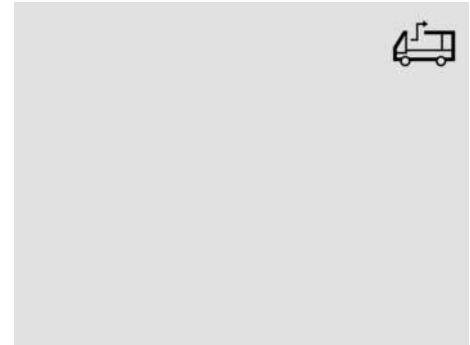

M54\_00-0610-01

Displayed if the roof hatches are open.

## Fuel level low (permanent display)



M54\_00-0614-01

**Note:**

Display for fuel level in reserve range.

## 3.) Bus stop mode displays

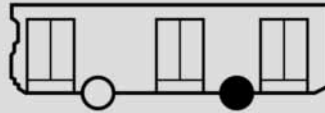

**Markt Bahnhof**  
**12:35 H 23122 +5**

M54.00-0174-01

This display mode is activated when the bus is stationary, the parking brake or bus stop brake is applied and the drive-off lock is still active. The bus symbol is always displayed for this display mode.

**Note:**

Also displayed is information from the computer-controlled operation management system (option).

### Continuation: bus stop mode

**A**

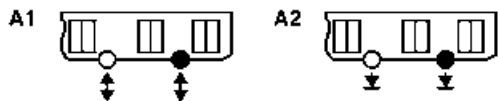

**B**

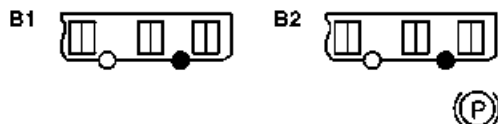

**C**

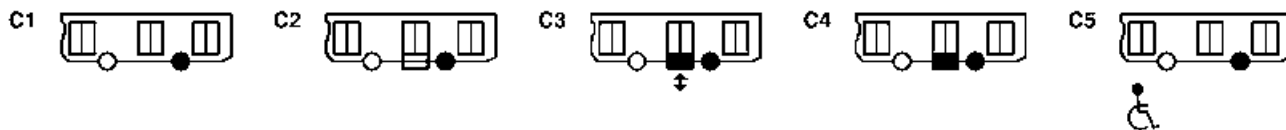

**D**

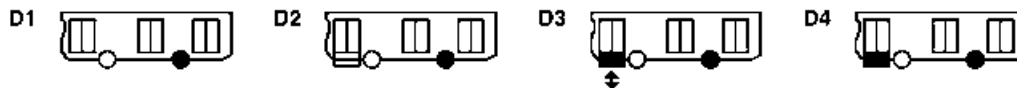

**E**



A - Bus symbols for the lowering system

- A1 *Arrows flashing = lowering active*
- A2 *Arrows permanently displayed = lowering complete*

B - Bus symbols for the brake system

- B1 *Permanent wheel display = drive-off lock or bus stop brake active*
- B2 *Permanent wheel display with parking brake symbol = parking brake applied*

C - Bus symbols for the ramp

- C1 *Permanent bus display = ramp retracted, not enabled*
- C2 *Ramp flashing = ramp enabled*
- C3 *Arrow flashing = ramp in operation*
- C4 *Permanent ramp display = ramp extended*
- C4 *Ramp flashing = ramp malfunction*
- C5 *Permanent bus display with wheelchair symbol = ramp requested*

D - Bus symbols for the lift

- D1 *Permanent bus display = lift retracted (out-of-use position), not enabled*
- D2 *Lift flashing = lift enabled*
- D3 *Arrow flashing = lift in operation*
- D4 *Permanent lift display = lift lowered*

- D4 *Lift flashing = lift malfunction*

E - Bus symbols for the doors

- E1 *Permanent bus display = doors closed, not enabled*
- E1 *Door flashing = door closed, enabled*
- E2 *Permanent door display = door open*
- E2 *Door flashing = door malfunction*
- E3 *Permanent door display = door disabled*
- E4 *Permanent door leaf display = door leaf disabled*
- E5 *Permanent bus display with pushchair symbol = hold door open requested or activated (pushchair switch)*

### Malfunction displays: description

#### Malfunction displays: description

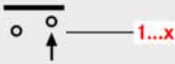

Störung — 1  
Anfahrhilfe

M54\_30-0099-71

A distinction is made between major and minor malfunctions. Malfunctions that have occurred are displayed on the screen with a malfunction display. Malfunction displays always consist of a symbol (1...x) and a malfunction text (1). They are displayed one under the other on the screen.



#### Note:

The malfunction texts are displayed in the language selected.

#### Major malfunctions

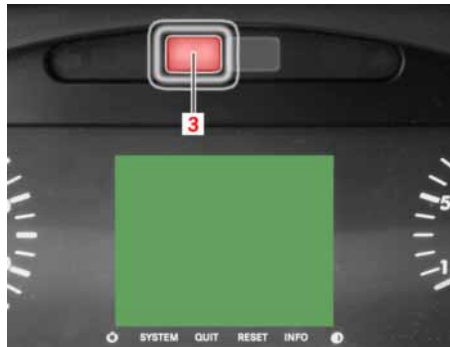

M54\_00-1362-71

Major malfunctions are displayed immediately in conjunction with red warning lamp (3) and remain active until the malfunctions have been rectified. A warning signal also sounds. It is not possible to clear the malfunction display or switch to a different display mode.



#### Danger.

Risk of accident. Red warning level malfunctions (3) indicate that the operating safety or roadworthiness of the bus is at risk. The driving and braking characteristics of the bus may change. The bus must be stopped immediately (traffic conditions permitting) and an EvoBus Service Partner must be notified.

#### Minor malfunctions

Minor malfunctions are subdivided into warning levels A, B and C. Minor malfunctions from warning levels A and B are displayed immediately as they occur in conjunction with yellow warning lamp (4). No warning signal sounds.

### Malfunction displays: red warning level - description

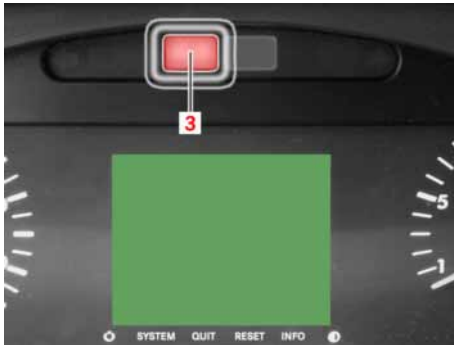

M54\_00-1362-71

A malfunction that is signalled by red warning lamp (3) immediately causes the malfunction display to be shown on the screen. Malfunction displays with red warning lamp (3) remain active on the screen until the malfunctions have been rectified. The malfunction display cannot be cleared if the red warning lamp is lit.



**Danger.**

Risk of accident. Red warning level malfunctions (3) indicate that the operating safety or roadworthiness of the bus is at risk. The driving and braking characteristics of the bus may change. The bus must be stopped immediately (traffic conditions permitting) and an EvoBus Service Partner must be notified.



**Danger.**

Risk of accident. If the rear car begins to swing from side to side, the bus must be stabilised by braking. If a malfunction occurs in the anti-jackknifing protection system (red warning lamp in conjunction with the "Anti-jackknifing protection" symbol), it is permissible to drive the bus as far as the nearest workshop but only in exceptional cases, in favourable weather conditions (non-skid road surface) and at a speed of no more than 12 mph (20 km/h). In all other cases the bus must be towed.

### Malfunction displays: red warning level - overview

#### Malfunction displays: red warning level - overview





Malfunction displays: red warning level - overview



**Note:**

Depending on the type of malfunction, the same symbol may be displayed with a different malfunction text, see symbol (10) for example.

- 10
- 1 Brake pressure signal malfunction
- 2 Supply pressure too low (brake circuit 1)
- 3 Supply pressure too low (brake circuit 2)
- 4 ABS/ASR failure
- 5 Drive control failure
- 6 Engine control failure
- 7 Transmission malfunction
- 8 Transmission oil too hot
- 9 No oil pressure
- 10 Oil level too low, check oil level

- 10 Engine oil replenishment failure. Oil level too low, check oil level. (Only in buses with automatic oil replenishment)
- 11 Coolant too hot
- 12 Hydrostatic fan drive malfunction
- 13 Door system malfunction
- 14 Emergency switch operated
- 15 Level control failure
- 16 Entry aid malfunction
- 17 Fuel level too low
- 18 No battery charge
- 19 FPS module 1 malfunction
- 20 Headroom clearance warning
- 21 Engine compartment fire message
- 22 Roof hatch emergency release



**Note:**

There may be up to 8 FPS modules in the bus. The number (1...8) referring to the module concerned is shown after the malfunction text

- 23 Anti-jackknifing system malfunction (articulated buses only)
- 24 Auxiliary steering malfunction (buses with trailing axle only)
- 25 Engine compartment fire

### Malfunction displays: yellow warning level A - description

#### Malfunction displays: yellow warning level A - description

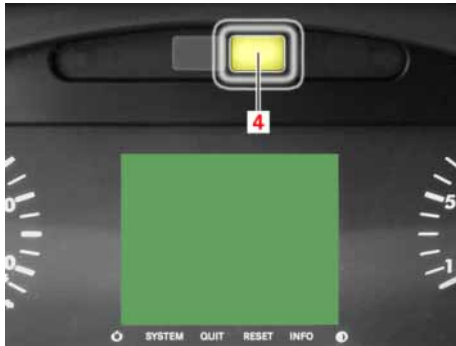

M54\_00-1363-71

Important message for the driver. Malfunction displays of warning level A are displayed immediately in conjunction with yellow warning lamp (4).



#### Caution:

In the event of a yellow warning level malfunction, it is permissible to drive on carefully but the bus should be checked by an EvoBus Service Partner at the earliest opportunity.



### Malfunction displays: yellow warning level A - overview

#### Malfunction displays: yellow warning level A - overview



Malfunction displays: yellow warning level A - overview



**Note:**

Depending on the type of malfunction, the same symbol may be displayed with a different malfunction text, see symbol (15) for example.

1 ABS/ASR failure



**Note:**

If the "Bus stop brake malfunction" message is also displayed on the screen, the bus stop brake is no longer operational.

1 ASR trailing axle malfunction (buses with four axles only)



**Danger.**

The bus may continue to be driven but with added caution (route can be completed) and must be inspected as soon as possible in the workshop. There is a possibility of a degradation in braking performance. Traction could be limited on slippery surfaces.

2 Parking brake malfunction

3 Retarder malfunction

4 Bus stop brake malfunction

5 Undervoltage

6 No battery charge

7 No battery charge

8 No battery charge

9 Fuel level too low

10 Supply pressure too low

11 Level control malfunction

12 Entry aid malfunction

13 Anti-jackknifing system malfunction (articulated buses only)

14 Auxiliary steering malfunction (buses with trailing axle only)

15 Oil level too low, check oil level

15 Engine oil replenishment failure. Oil level too low, check oil level. (Only in buses with automatic oil replenishment)

15 Oil level too high, check oil level



**Caution:**

There is a risk of engine damage if the oil level is too low or too high. Therefore, correct the oil level as soon as possible.



**Note:**

Observe the "Display mode: bus stop mode - overview" section.

16 Air drier malfunction

17 AdBlue level too low

18 Fire detection system failure

### Malfunction displays: yellow warning level B - description

- 19 Fire extinguishing system failure
- 20 Engine torque reduction

#### Malfunction displays: yellow warning level B - description

Less important message for the driver. Malfunction displays of warning level B are displayed on screen (14) for approximately 10 seconds in conjunction with yellow warning lamp (5). Once the malfunction display and yellow warning lamp (5) have gone out, the “Message available” symbol is shown on the screen.

#### Symbol Description



The “Message available” symbol on the screen indicates that it is possible to call up a message (malfunction, maintenance due) from a system.



### Malfunction displays: yellow warning level B - overview

#### Malfunction displays: yellow warning level B - overview

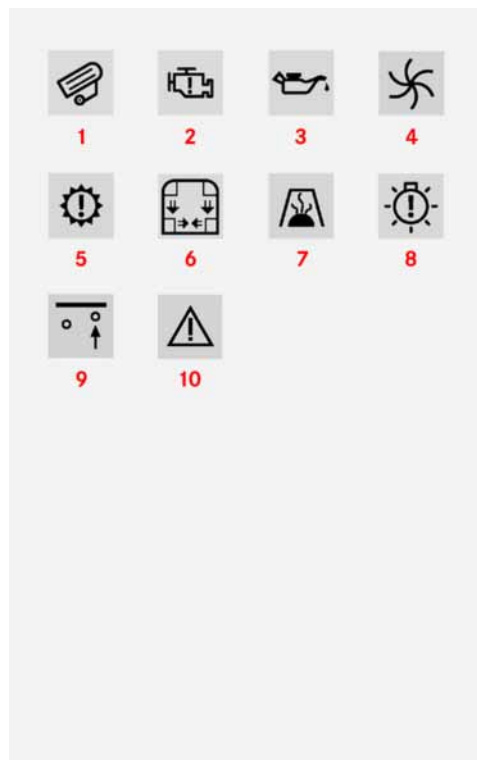



Malfunction displays: warning level C - description



Note:

Depending on the type of malfunction, the same symbol may be displayed with a different malfunction text, see symbol (8) for example.

|   |  |    |   |
|---|--|----|---|
| 1 | Drive control failure                                | 8  | Exterior lighting malfunction, front foglamps                     |
| 2 | Engine control failure                               | 8  | Exterior lighting malfunction, brake lamps                        |
| 3 | No oil pressure                                      | 8  | Exterior lighting malfunction, auxiliary brake lamps              |
| 4 | Hydrostatic fan drive malfunction                    | 8  | Exterior lighting malfunction, reversing lamps                    |
| 5 | Transmission malfunction                             | 8  | Exterior lighting malfunction, tail lamps                         |
| 6 | Heating/ventilation malfunction                      | 8  | Exterior lighting malfunction, side lamps                         |
| 7 | Auxiliary heating malfunction                        | 8  | Exterior lighting malfunction, licence plate lamps                |
| 8 | Exterior lighting malfunction                        | 8  | Front turn signals malfunction                                    |
| 8 | Exterior lighting malfunction, dipped-beam headlamps | 8  | Rear turn signals malfunction                                     |
| 8 | Exterior lighting malfunction, main-beam headlamps   | 8  | Additional turn signal lamps malfunction                          |
| 8 | Exterior lighting malfunction, rear foglamp          | 9  | Pull-away aid malfunction (buses with trailing axle only)         |
|   |  | 10 | Gas system malfunction (compressed natural gas CNG vehicles only) |

Malfunction displays: warning level C - description

Not an important message for the driver. No malfunction display is shown on the screen. Yellow warning lamp (5) remains off. Only the "Message available" symbol is shown on the screen.

Symbol Description



The "Message available" symbol on the screen indicates that it is possible to call up a message (malfunction, maintenance due) from a system.

### Malfunction displays: warning level C - overview

#### Malfunction displays: warning level C - overview



## Selecting the language on the screen



### Note:

Depending on the type of malfunction, the same symbol may be displayed with a different malfunction text, see symbol (8) for example.

- 1 Brake pad thickness too low
- 2 Brake pressure signal malfunction
- 3 Coolant level too low
- 4 Hydrostatic fan drive, check oil level
- 5 Read the fault memory
- 6 FPS module 1 malfunction



### Note:

There may be up to 8 FPS modules in the bus. The number (1...8) referring to the module concerned is shown after the malfunction text.

- 7 Lubrication system malfunction

- 8 Auxiliary steering malfunction, oil level low (buses with trailing axle only)
- 8 Auxiliary steering malfunction, replace filter (buses with trailing axle only)

### Selecting the language on the screen



### Note:

Precondition: bus stationary, parking brake applied.

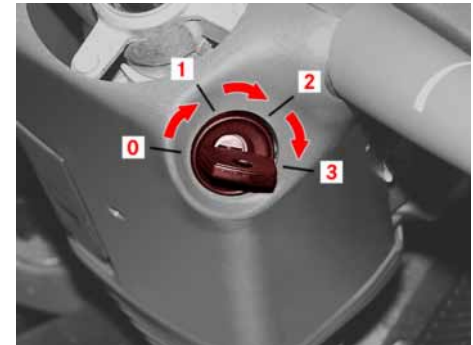

M54.00-0083-01

- ▶ Ignition switch position (0).

### Selecting the language on the screen

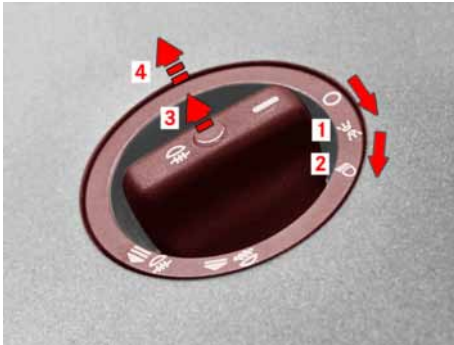

M54.00-0068-01

- ▶ Switch on side lamps (1).

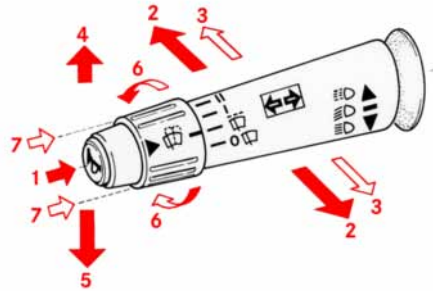

M54.00-0081-01

- ▶ Slide sleeve (7) on the steering column switch (wipe/wash) towards the steering column for longer than 5 seconds.

The language control menu (country codes) appears on the screen.

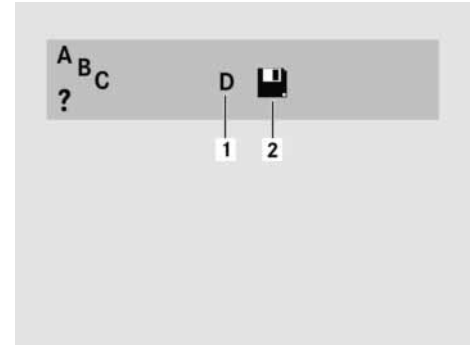

M00\_00-0321-01

- ▶ It is now possible to select the language required by pressing the steering column switch down (to scroll down) or up (to scroll up).
- ▶ To save the displayed language (1), slide and hold the sleeve on the steering column switch again. Disk icon (2) flashes while saving is in progress.

- ▶ Saving is complete when flashing disk icon (2) lights up permanently. Releasing the sleeve exits the selection menu.

**Note:**

It is possible to cancel the process at any time by switching off the side lamps.

**General Information / Safety Information****Vehicle manoeuvrability when the air suspension is depressurised**

The front chassis and driven axle guide have been designed so that the bus is guaranteed to be manoeuvrable even when the suspension air bags are depressurised.

In this condition, the whole weight of the bus lays on the stop buffers built into the front chassis and rear axle. They are not used when the suspension operates normally and only prevent the bus hitting the axle when compression is extreme. The stop buffers have not been designed to be operated under continuous loading and cannot be considered a replacement for the normal suspension under any circumstances. Additionally, the bodywork can be damaged (cracks etc.).

**Danger.**

Although the vehicle remains manoeuvrable when the suspension is depressurised, it must only be driven at walking pace to the nearest lay-by or EvoBus Service Partner. The body must always be secured at the correct points by using jacks and floor stands whenever work is carried out on the pneumatic suspension system as the vehicle body can sink relatively quickly if there is an air loss.

### Lowering/raising the bus on the entry side

#### Lowering/raising the bus on the entry side



#### Note:

Precondition: electrical system on, bus stationary, doors closed, operating pressure > 6.5 bar, red indicator lamp off, lowering/raising with key switch on, level control operational.



#### Danger.

Risk of accident. Use the lowering function only with the bus stationary and for no purpose other than as a boarding aid.



#### Danger.

Risk of accident. Ensure that no objects or persons are present under the bus, particularly their feet.

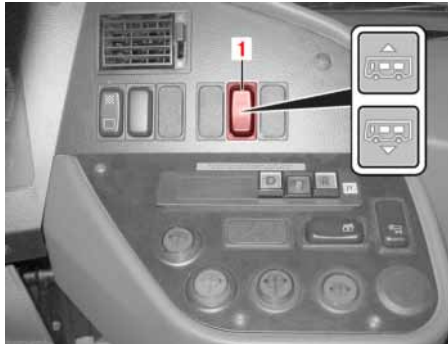

M54\_00-1323-71

- ▶ Press and hold pushbutton (1) until the bus is lowered.  
The bus lowers on the entry side.

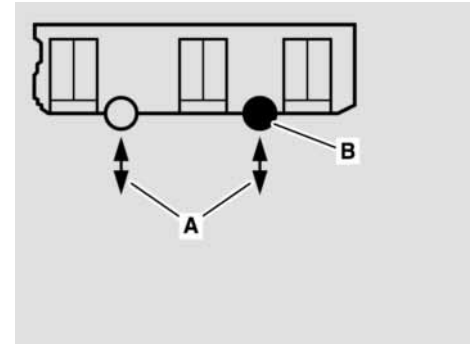

M54.00-0230-01

While the bus is being lowered, the screen shows: "Bus lowering" (A), "Drive-off lock active" (B).

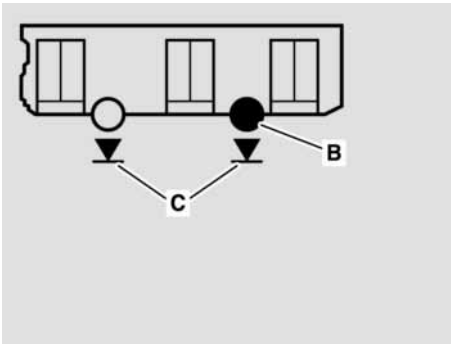

M54.00-0231-01

After the lowering process, the screen shows: “Lowering complete” (C), “Drive-off lock active” (B).



**Note:**

After the bus has been lowered, it is possible to open the doors and extend the ramp.

- ▶ Briefly press the upper section of pushbutton (1).

The bus is raised back to the normal level.



**Note:**

Doors must be closed.

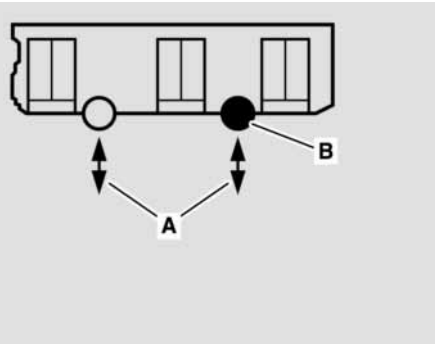

M54.00-0230-01

While the bus is being raised, the screen shows: “Bus rising” (A), “Drive-off lock active” (B).

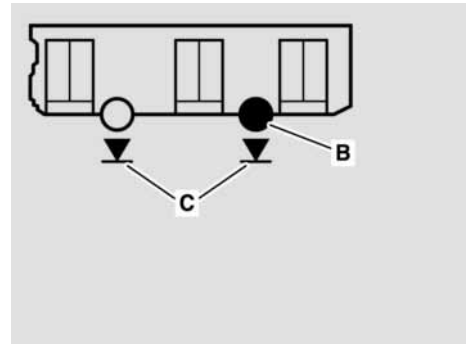

M54.00-0231-01

After the raising process, the screen shows: “Raising complete” (C), “Drive-off lock active” (B).



**Note:**

The bus is raised automatically if the doors are closed or pushbutton (26) is released during the lowering process.

### Raising the bus above normal level

#### Raising the bus above normal level



##### Note:

Precondition: electrical system on, bus stationary, doors closed, operating pressure > 6.5 bar, red indicator lamp off, lowering/raising with key switch on, level control operational.



##### Danger.

Risk of accident. Do not exceed the maximum permissible vehicle height when driving with the bus raised above normal level. In Germany, the maximum permissible vehicle height is limited to 4 metres. Observe local statutory regulations in all other countries (especially in the event of cross-border travel).



M54\_00-1335-71

- ▶ Press the upper section of pushbutton (1) in bus stop mode.

The bus is raised for as long as the pushbutton is pressed.



##### Note:

Release the pushbutton when the bus has reached the required height.

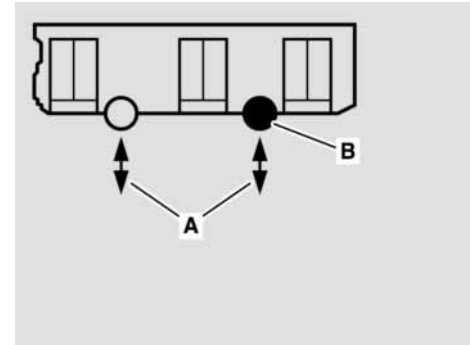

M54.00-0230-01

The following is shown on the screen: "Raised level active" (A).



##### Note:

This function is displayed if the "Bus stop mode" display is active.

- ▶ Briefly press the upper section of pushbutton (1) in driving mode.

The bus is raised for as long as the pushbutton is pressed.



## Raising the bus above normal level

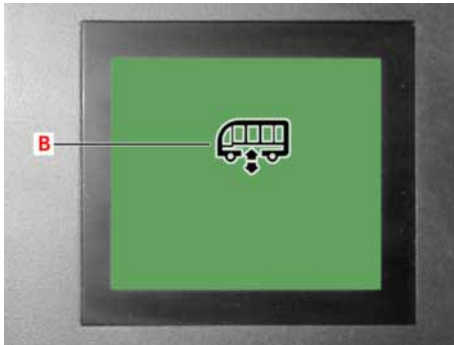

M54\_00-1359-71

The buzzer sounds briefly. The yellow warning lamp lights up briefly.

The following is shown on the screen: “Bus raised” (B).



### Note:

This function is displayed if the “Driving mode” display is active.



### Note:

Release the pushbutton when the bus has reached the required height.



M54\_00-1335-71

- ▶ Briefly press the lower section of pushbutton (1).

The bus is lowered to the normal level.

The function indicator on the screen goes out.



### Note:

Lowering is cancelled if the upper section of pushbutton (1) is pressed during the lowering process.

### Applying the parking brake

#### Applying the parking brake



#### Note:

Precondition: minimum operating pressure of 5.5 bar.



#### Danger.

Risk of accident. There is a fault in the parking brake circuit if the "Brake system malfunction" indicator lamp lights up while there is sufficient operating pressure. Have the brake system checked at an EvoBus Service Partner.

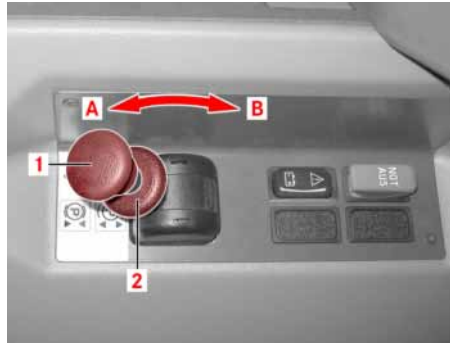

M42\_00-0650-71

- ▶ Pull parking brake lever (1) back (A) and engage it.

The parking brake is applied (air venting noise can be heard).



#### Danger.

Do not apply the parking brake unless the bus is stationary. Always apply the parking brake before you leave the driver's area. On uphill and downhill gradients, you must also chock the wheels and turn the steering towards the kerb.



#### Danger.

Check the hand lever for full engagement. Do this by pressing hand lever (1) towards released position (B) without pulling release ring (2) out of the detent position. The lever must not move.

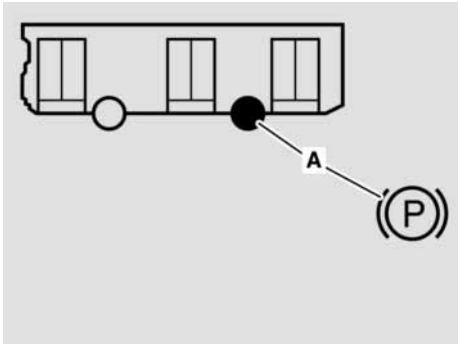

M54.00-0232-01

The following is shown on the screen: "Parking brake applied" (A).

### Releasing the parking brake

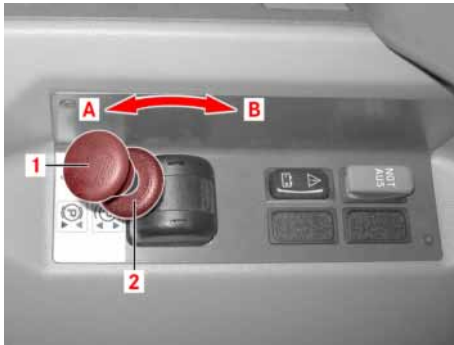

M42\_00-0650-71

- Pull locking ring (2) up and press parking brake lever (1) forwards (B).

The parking brake is released (air charging noise can be heard).

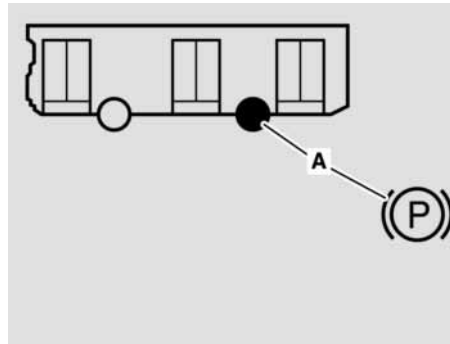

M54.00-0232-01

The “Parking brake applied” indication display (A) on the screen goes out.



#### Note:

A continuous warning tone sounds if the electrical system is switched off with the parking brake released.



#### Note:

To guarantee a faultless release of the parking brake, the supply pressure must be at least 5.5 bar. If the parking brake indicator lamp goes out despite there being sufficient supply pressure, there is a fault in the spring actuator or the emergency release circuit. Have the brake system checked by an EvoBus Service Partner immediately.

### Emergency braking in the event of failure of both brake circuits

#### Emergency braking in the event of failure of both brake circuits



**Danger.**

A failure in brake circuits 1 and 2 will jeopardise the operating safety and road-worthiness of the bus. Stop the vehicle immediately (traffic conditions permitting). Have the brake system checked by an EvoBus Service Partner immediately.



**Note:**

In the event of a failure in brake circuits 1 and 2, it is possible to initiate emergency braking using the parking brake lever.

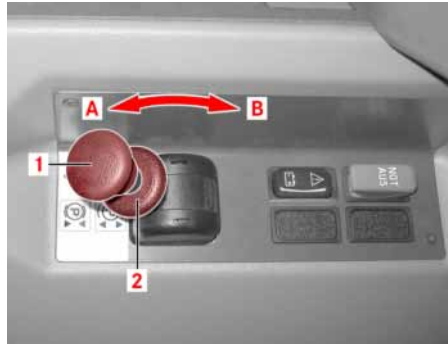

M42\_00-0650-71

- ▶ Pull release ring (2). Slowly pull the hand lever towards the Applied position (A) and hold it in the desired position, otherwise it will automatically return to the Released position (B).



**Danger.**

When performing emergency braking using the parking brake, make sure that the parking brake lever does not engage in the parking position. Release ring (2) must be held in the applied position.

The bus is braked at the rear wheels only.



**Note:**

It is possible to pull the parking brake lever back to any position before the limit position. This enables you to prevent the rear wheels from locking and to control the amount of braking force applied.



**Danger.**

Risk of accident. The anti-lock braking system (ABS) is not operational when the parking brake is applied. You should pay particular attention when driving on slippery roads, since the rear wheels could lock.

### Activating/deactivating the bus stop brake



#### Note:

Precondition: bus stationary, electrical system on.



#### Danger.

If the bus stop brake is not used as intended, the vehicle could roll away. This could result in an accident with serious or fatal injuries. Therefore: - Before starting/stopping the engine and before leaving the driver's area, always apply the parking brake. - Do not under any circumstances use the bus stop brake to park the bus or to secure it against rolling away. - Apply the parking brake when stopping on steep uphill or downhill gradients exceeding 15 % or at bus stops on steep uphill or downhill gradients exceeding 15 %. - Do not activate the bus stop brake unless the vehicle is stationary.



M54\_00-1283-71

- ▶ Press the lower section of switch (1).  
The bus stop brake is active.

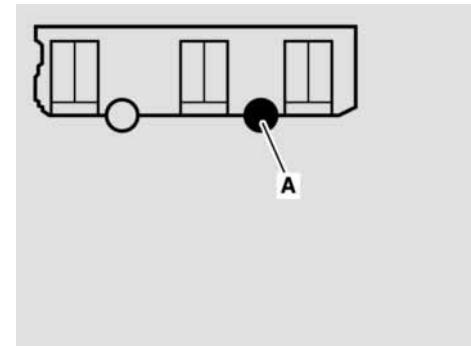

M54.00-0237-01

- The following is shown on the screen: "Bus stop brake active" (A).
- ▶ Press the upper section of switch (25); depress the accelerator pedal.  
The bus stop brake is released.



#### Note:

The drive-off lock is not released until the accelerator pedal is depressed.

## Drive-off lock

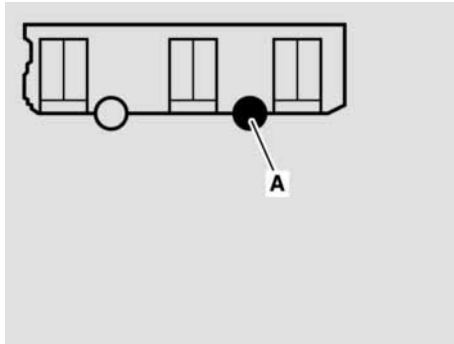

M54.00-0237-01

The “Bus stop brake active” indication display (A) on the screen goes out.

### Drive-off lock



#### Note:

Precondition: bus stationary, electrical system on.



#### Danger.

If the drive-off lock is not used as intended, the vehicle could roll away. This could result in an accident with serious or fatal injuries. For this reason, the parking brake must always be applied before you start/stop the engine or leave the driver's area. Do not use the drive-off lock to park the bus or secure the bus against rolling away under any circumstances. Engage the parking brake when stopping on steep uphill or downhill gradients of more than 15 % and at bus stops on steep uphill or downhill gradients of more than 15 %.

- ▶ Open the door

The following is shown on the screen: “Drive-off lock active” (A). Addition-

ally, the status indicator for the action is also displayed.

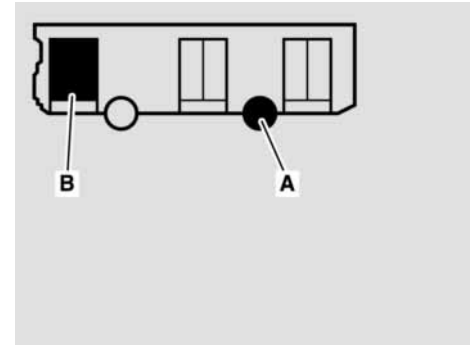

M54.00-0235-01

In the example: “Door open” (B).



#### Note:

The drive-off lock is also activated if the following functions are active: “Lower bus”, “Operate ramp”, “Operate lift”.

- ▶ Close the door, depress the accelerator pedal.

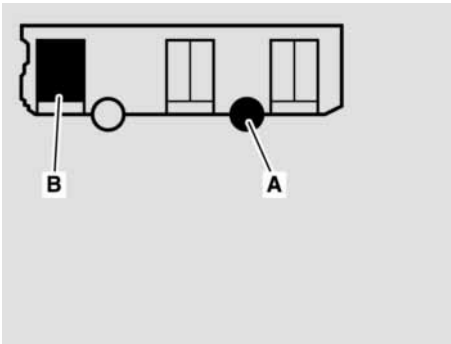

M54.00-0235-01

The “Drive-off lock active” indication display (A) on the screen goes out.

**Note:**

The drive-off lock is only released when the accelerator pedal is depressed.

### General Information / Safety Information

#### Important notes on the steering system

The dimensions of the steering system and the mechanical steering transmission ratio were designed such that, in the event of a malfunction in the hydraulic power steering system, the effort required to turn the steering wheel would not exceed a specific value deemed by legislators to be the maximum reasonable force.

For vehicles above 12 t this force is 450 N (400 N for vehicles between 3.5 t and 12 t) applied to the steering wheel circumference when turning the vehicle from straight-ahead driving into a circle with a 20 m radius at a road speed of approximately 10 km/h. No more than 6 seconds must pass from the start of turning to reaching the 20 m radius.

The driver must be aware that, in the event of a sudden failure in the power steering (e.g. due to a pump drive malfunction), the bus will remain steerable

but considerably more effort will be required.

Since there is an extremely low probability of this situation occurring - but if it does occur, it often does so completely unexpectedly - the driver could wrongly assume that the steering system has been blocked. In fact, the driver merely has to use the level of effort required to continue steering.

This important information is intended to clarify the scenario described and prevent the driver from possibly misjudging the situation.

**Danger.**

In the event of a power steering failure, the bus becomes very difficult to steer. Have the malfunction rectified immediately at an EvoBus Service Partner.

### Adjusting the steering column

#### Adjusting the steering column



M46.00-0030-01

- ▶ To adjust the steering column, press the lower section of pushbutton (1).



#### **Danger.**

Only make adjustments when the bus is stationary. Lock the steering column in place after you have adjusted the steering wheel to match the driver's requirements. To do this, press the upper section of pushbutton (1).



#### **Note:**

If pushbutton (1) is not pressed again the steering column will automatically lock after approx. 12 seconds.



#### **Danger.**

After the adjustable steering column has been adjusted, the driver must check that all instruments and indicator lamps are still visible.

#### Turning the steering wheel when the bus is stationary

- ▶ Adhere to the instructions.



#### **Note:**

To prevent damage to the steering column, the following points must be observed when turning the steering wheel with the bus stationary, without hydraulic support (engine switched off) and without a turntable under the front wheels (tyres in direct contact with the ground):

- ▶ Release the steering wheel adjuster and push the steering wheel fully down. Lock the steering wheel adjuster in place. Turn the steering wheel using both hands at an angle of 90° to 180° to one another.



#### **Caution:**

Never have more than one person turn the steering wheel. Do not pull the steering wheel on one side only.



### Switching the mirror and window heating on and off



**Note:**

We ask the workshop in particular to note this.

#### Switching the mirror and window heating on and off



**Note:**

Precondition: engine running.



**Note:**

The window and the exterior mirror heating is limited to approximately 12 minutes.



M54\_00-1299-71

- ▶ Press the lower section of pushbutton (1).

The indicator lamp in pushbutton (1) lights up.

The heating is active.

### Switching the mirror and window heating on and off

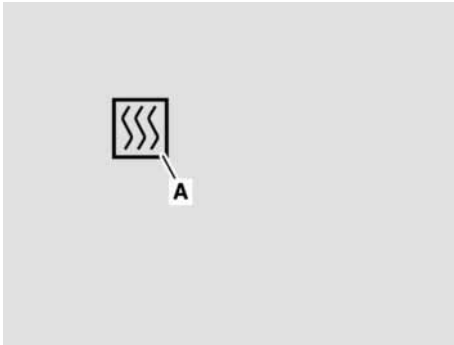

M54.00-0243-01

The following is shown on the screen:  
“Window/exterior mirror heated” (A).

- ▶ Press the upper section of pushbutton (7).

The indicator lamp in switch (7) goes out.

The heating is switched off.

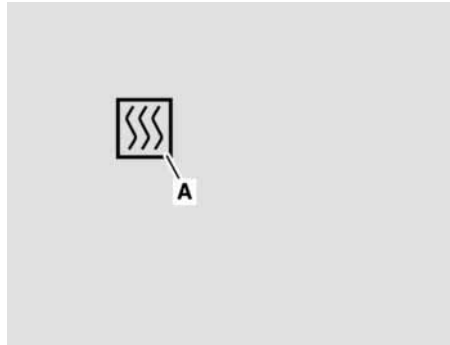

M54.00-0243-01

The “Window/exterior mirror heated”  
indication display (A) on the screen  
goes out.

|  |            |
|--|------------|
| <b>Important notes on the driver's seat .....</b>            | <b>146</b> |
| <b>Grammer MSG 90.5 driver's seat control elements .....</b> | <b>148</b> |
| <b>Using the driver's seat belt .....</b>                    | <b>150</b> |

### Important notes on the driver's seat

#### Important notes on the driver's seat

It is essential that the following instructions be observed:



#### **Danger.**

In the interests of road safety, the driver's seat must not be adjusted when the bus is in motion.



#### **Note:**

The following descriptions provide a brief overview of the control elements. The manufacturer's operating instructions provided must be observed in all cases.



## Driver's seat/passenger seats

### Grammer MSG 90.5 driver's seat control elements

#### Grammer MSG 90.5 driver's seat control elements

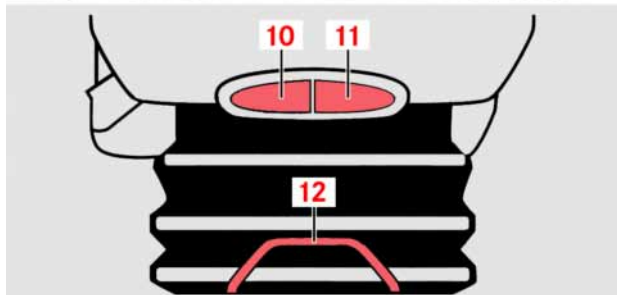
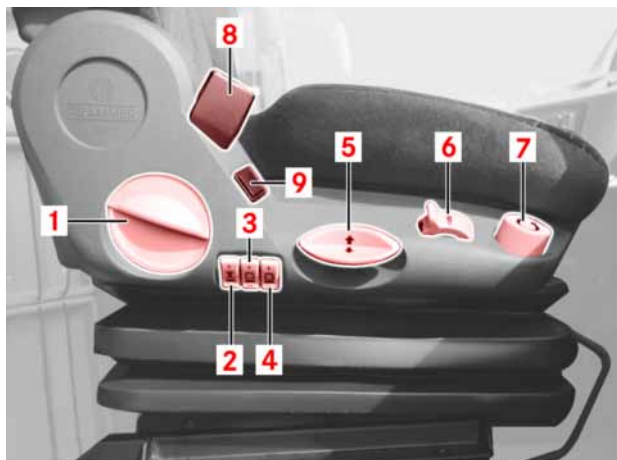

## Grammer MSG 90.5 driver's seat control elements

1 Backrest adjustment



**Note:**

Relieve load on backrest, pull lever upwards, move into required position, release lever.

2 Lateral support adjustment



**Note:**

Individually adjustable lateral support by two compressed-air chambers. (+) chamber fills up or (-) chamber empties.

3 Lumbar support (upper chamber)



**Note:**

(+) chamber fills up or (-) chamber empties.

4 Lumbar support (lower chamber)



**Note:**

(+) chamber fills up or (-) chamber empties.

5 Height adjustment



**Note:**

Pull lever up = upward adjustment. Push lever down = downward adjustment.

6 Damper setting



**Note:**

The damper setting can be infinitely adjusted between soft and hard.

7 Swivel release mechanism



**Note:**

Press button downwards: the seat can now be turned (swivel range: 50° to the left, 90° to the right).

8 Seat belt buckle

9 Seat heating switch (option)

10 Seat cushion angle adjustment



**Note:**

Relieve load on backrest, pull button upwards: the seat angle can now be adjusted.

11 Seat cushion depth adjustment



**Note:**

Pull button upwards: the seat cushion can now be adjusted.

12 Driver's seat fore-and-aft adjustment



**Note:**

Pull lever upwards: the seat can now be slid in the longitudinal direction.

### Using the driver's seat belt

#### Using the driver's seat belt



**Note:**

The driver's seat fitted has an integrated belt system. The user instructions therefore only apply to belts that were installed in the manufacturing plant.



**Note:**

Section 21a of the German road traffic regulations (StVO) stipulates that the seat belt must be buckled while the vehicle is in motion. Observe the legal requirements in all countries concerned.

- ▶ Fastening the seat belt: pass the seat belt untwisted and tightly across your pelvis and shoulder and insert the tongue into the belt buckle until you hear it engage.



**Danger.**

The seat belt must not pass over your neck, be snagged or rub against sharp edges. It should fit as close to the body as possible. You should therefore avoid wearing bulky clothing. Do not route the seat belt over solid or fragile objects in pockets in your clothing. Frequently retighten the seat belt over your shoulder.

- ▶ Releasing the seat belt: press the red button in the belt buckle and assist the inertia reel by guiding the seat belt back.



|   |            |
|---|------------|
| <b>Automatic transmission - general information</b> .....         | <b>152</b> |
| <b>Gearshift positions of the 3-pushbutton switch panel</b> ..... | <b>153</b> |
| <b>Gearshift positions of the 6-pushbutton switch panel</b> ..... | <b>154</b> |

## Automatic transmission - general information

### Automatic transmission - general information



#### **Danger.**

Risk of accident. The bus is free to move with the transmission in neutral “N” and the brakes released. Apply the parking brake and press pushbutton N whenever the bus is parked or work is to be carried out on the bus with the engine running. Do not shift down on a slippery road surface (risk of skidding). Press pushbutton N when there is a risk of sliding and skidding. For a brief stop, such as at a bus stop or traffic lights, keep the gearshift unit in its current position and bring the bus to a halt using the service brake or bus stop brake. Shift down in good time on long uphill or downhill gradients, especially if the vehicle is under considerable load.



#### **Note:**

Changing gear with the automatic transmission: The engine cannot be started unless the transmission is in neutral position “N”. The individual gears are changed automatically in response to the position of the switches, the road speed and the accelerator pedal position.



#### **Note:**

Pulling away: Apply the service brake. Select the gearshift position by pressing a pushbutton with the engine at idling speed (accelerator pedal not depressed). Do not release the brake until the bus begins to pull away. There is otherwise a risk of the bus pulling away too soon (bus creeps). On an uphill gradient, release the brake pedal and depress the accelerator pedal at the same time.



#### **Note:**

Accelerator pedal positions: Little throttle for low acceleration and sooner upshifts. More throttle for high acceleration and later upshifts. Kickdown (depressing the accelerator pedal to the stop beyond the full throttle position) for maximum acceleration. The transmission shifts down to a lower gear if the road speed is below the maximum speed for the next gear down. The transmission shifts up when the engine is running at rated speed.

## Gearshift positions of the 3-pushbutton switch panel

### Gearshift positions of the 3-pushbutton switch panel

 **Note:**

Precondition: pushbutton “N” pressed, bus stationary, service brake applied, accelerator pedal released (engine speed < 900 rpm).

 **Note:**

Each button lights up when pressed.

 **Caution:**

If the pressed button begins to flash, this is a warning that there is a severe risk of transmission damage (limited system monitoring). In this event, it is permitted to drive on to the nearest workshop but only with the engine under partial load.



**Caution:**

Observe the towing guidelines if the transmission is damaged.

▷ The towing guidelines are described in the general information section.

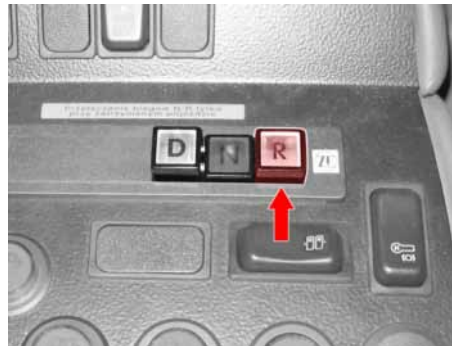

M54\_00-1331-71

▶ Press switch “R”.

The automatic transmission shifts to reverse gear.



**Danger.**

Risk of accident. Do not shift into reverse gear unless the bus is stationary and the engine is running at idling speed.



**Note:**

It is necessary to press the “N” button first if button “D” is pressed after button “R” or if button “R” is pressed after button “D”.



**Note:**

During reverse travel, a warning tone will sound if this feature has been requested by the customer or stipulated by national regulations.

### Gearshift positions of the 6-pushbutton switch panel

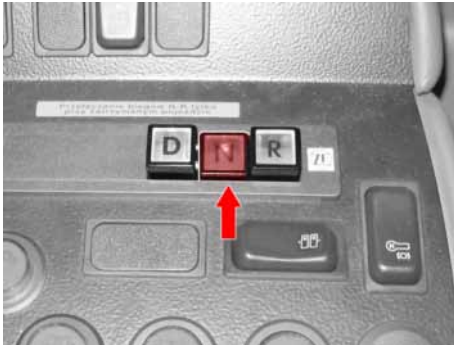

M54\_00-1332-71

- ▶ Press switch “N”.

The automatic transmission shifts to neutral.

The bus is free to move if no brakes are applied. There is no power transmission from the engine to the driven axle.

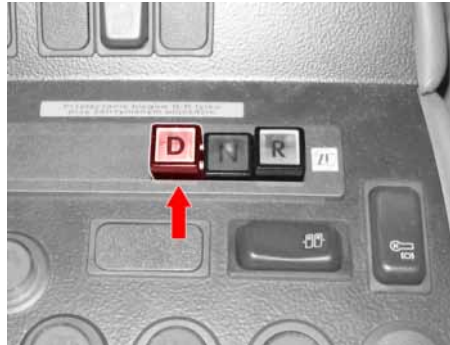

M54\_00-1333-71

- ▶ Press switch “D”.

Gears 1 to 4 (4-speed transmission) or 1 to 6 (6-speed transmission) are automatically selected in succession.



#### Note:

Drive position “D” provides ideal driving characteristics in almost all operating situations.

### Gearshift positions of the 6-pushbutton switch panel



#### Note:

Precondition: pushbutton “N” pressed, bus stationary, service brake applied, accelerator pedal released (engine speed < 900 rpm).



#### Note:

Each button lights up when pressed.



#### Caution:

If the pressed button begins to flash, this is a warning that there is a severe risk of transmission damage (limited system monitoring). In this event, it is permitted to drive on to the nearest workshop but only with the engine under partial load.

## Gearshift positions of the 6-pushbutton switch panel



### Caution:

Observe the towing guidelines if the transmission is damaged.

▷ The towing guidelines are described in the general information section (“Operation” section of the Operating Instructions).

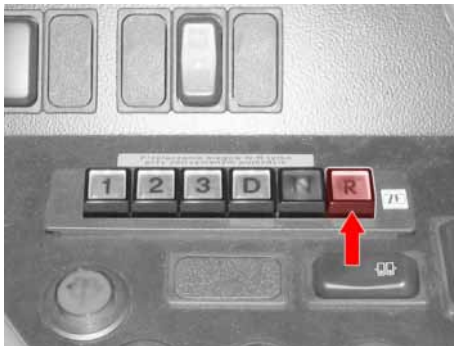

M54\_00-1340-71

▶ Press switch “R”.

The automatic transmission shifts to reverse gear.



### Danger.

Risk of accident. Do not shift into reverse gear unless the bus is stationary and the engine is running at idling speed.



### Note:

It is necessary to press the “N” button first if button “1” or “D” is pressed after button “R” or if button “R” is pressed after button “1” or “D”.



### Note:

During reverse travel, a warning tone will sound if this feature has been requested by the customer or stipulated by national regulations.

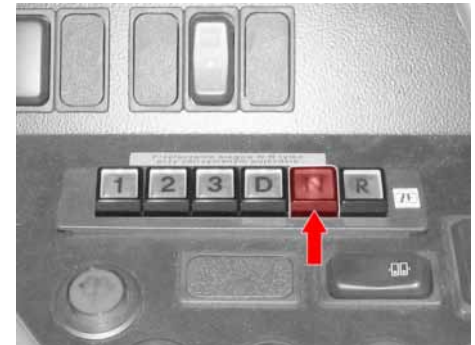

M54\_00-1341-71

▶ Press switch “N”.

The automatic transmission shifts to neutral.

The bus is free to move if no brakes are applied. There is no power transmission from the engine to the driven axle.

### Gearshift positions of the 6-pushbutton switch panel

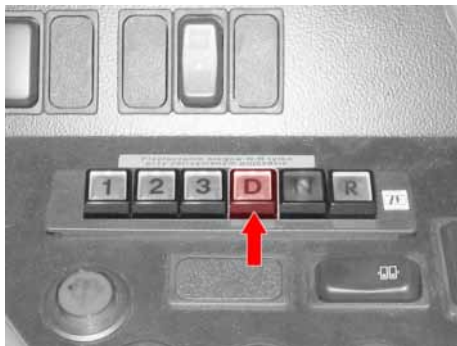

M54\_00-1342-71

- ▶ Press switch “D”.

Gears 1 to 4 (4-speed transmission) or 1 to 6 (6-speed transmission) are automatically selected in succession.



#### Note:

Drive position “D” provides ideal driving characteristics in almost all operating situations.

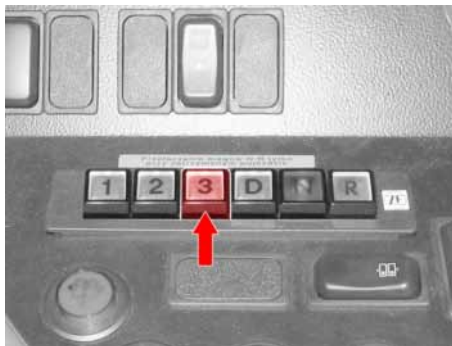

M54\_00-1343-71

- ▶ Press switch 3.

Gears 1 to 3 are automatically selected in succession.



#### Note:

For driving on slight to moderate uphill gradients to prevent pendulum-like gearshifting between the 3rd and 4th gear.

On a downhill gradient the engine braking effect can be utilised up to the permissible maximum engine speed in 3rd gear.

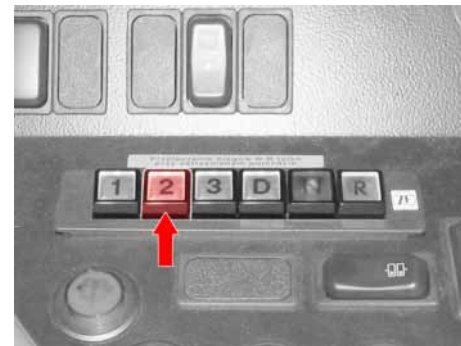

M54\_00-1344-71

- ▶ Press switch 2.

Gears 1 to 2 are automatically selected in succession.



#### Note:

For driving on moderate uphill gradients to prevent pendulum-like gearshifting between the 2nd and 3rd gear.

On a downhill gradient the engine braking effect can be utilised up to the permissible maximum engine speed in 2nd gear.

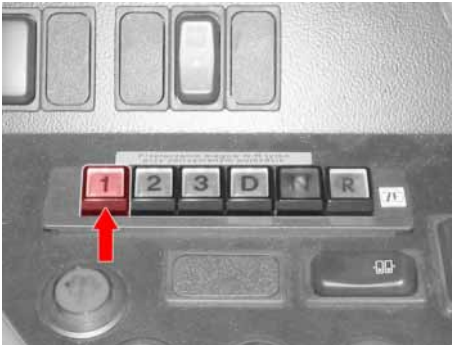

M54\_00-1345-71

- ▶ Press switch 1.

For driving on steep uphill gradients and for manoeuvring the bus at slow speeds.



#### Note:

Only 1st gear is selected.

On a downhill gradient the engine braking effect can be utilised up to the permissible maximum engine speed in 1st gear.





|  |            |
|--|------------|
| <b>Safety instructions for the air-conditioning system</b> .....                             | <b>161</b> |
| <b>Operating instructions for the air-conditioning system</b> .....                          | <b>161</b> |
| <b>Heating/ventilation/air-conditioning control panel - driver's area</b> .....              | <b>162</b> |
| <b>Heating/ventilation/air-conditioning control panel - whole bus</b> .....                  | <b>164</b> |
| <b>Driver's area - setting the air distribution/demisting the windscreen</b> .....           | <b>165</b> |
| <b>Driver's area - adjusting the temperature</b> .....                                       | <b>166</b> |
| <b>Driver's area - adjusting the blower speed</b> .....                                      | <b>167</b> |
| <b>Driver's area - cooling</b> .....   | <b>168</b> |
| <b>Additional driver's area ventilation (option)</b> .....                                   | <b>169</b> |
| <b>Switching air-recirculation mode on and off</b> .....                                     | <b>169</b> |
| <b>Passenger compartment - switching temperature control on and off - code HH2/HK1</b> ..... | <b>170</b> |
| <b>Passenger compartment - switching temperature regulation on and off</b> .....             | <b>171</b> |
| <b>Switching the auxiliary heating on and off</b> .....                                      | <b>172</b> |
| <b>Switching the reheat function on and off</b> .....  | <b>174</b> |
| <b>Passenger-compartment temperature - changing the base value</b> .....                     | <b>175</b> |
| <b>Opening the roof hatches</b> .....  | <b>179</b> |

## Table of contents

|  |     |
|--|-----|
| Fans on/off .....                              | 181 |
| Switching fans on and off - code HH2/HK1 ..... | 182 |
| Auxiliary heating digital timer (option) ..... | 184 |
| Auxiliary heating operation (option) .....     | 185 |

### Safety instructions for the air-conditioning system

Air-conditioning systems that are operated with refrigerant R 134 a are labelled with appropriate stickers and/or plates on the compressor.

Never mix R 134 a refrigerant and the corresponding DEA Triton SE 55 refrigerator oil with other products.

It is forbidden to disregard the latest technological standards and allow refrigerant to escape into the environment when servicing or decommissioning air-conditioning systems.

Refrigerant and refrigerator oils must be disposed of separately, or recycled.

Maintenance work on air-conditioning systems as well as removal of refrigerants and oils may only be carried out by persons who have the relevant and necessary specialist knowledge, technical equipment and official approval (control of health and safety at work, local government, TÜV).

The operator must maintain a logbook auditing the consumption of refrigerant and refrigerator oils.



#### **Danger.**

On automatically controlled air-conditioning systems, the ventilation blowers can be started at any time by the condenser or evaporator units. Therefore turn the ignition switch to the OFF position when carrying out cleaning work. Do not reach into the fan blades or fan rollers. Avoid any contact with refrigerant as there is a risk of frostbite. Treat affected skin areas as for frostbite, and contact a doctor straight away. Carry out maintenance and repair tasks with the engine switched off whenever possible. Keep a safe distance from moving parts (e.g. belt drive) when the engine is running.

### Operating instructions for the air-conditioning system



#### **Note:**

The driver's window should remain closed while the vehicle is in motion and the air-conditioning is operating to ensure faultless operation of the air-conditioning system.

### Heating/ventilation/air-conditioning control panel - driver's area

Heating/ventilation/air-conditioning  
control panel - driver's area

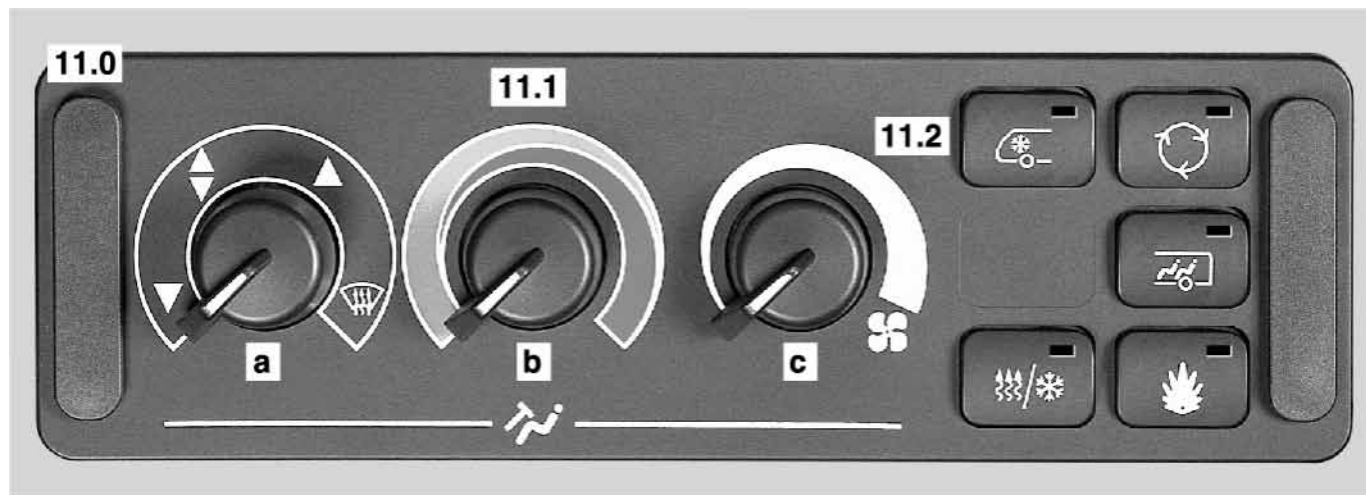

- A Air distribution
  - B Temperature control
  - C Blower output
- 11.2 Driver's area cooling

Heating/ventilation/air-conditioning  
control panel - whole bus

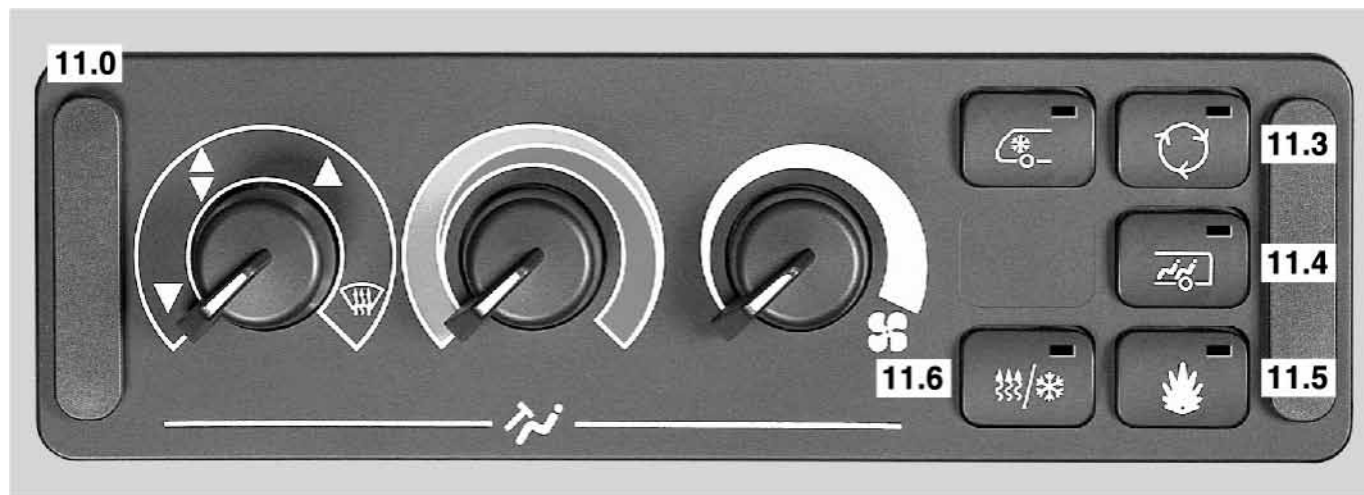

## Driver's area - setting the air distribution/demisting the windscreen

- 11.3
  - 1. Air-recirculation mode
  - 2. To increase the base value for the passenger-compartment temperature
- 11.4
  - 1. Passenger-compartment temperature control on/off
  - 2. To call up the program for changing the base value
  - 3. To confirm the base value for the passenger-compartment temperature
- 11.5
  - 1. Auxiliary heating on/off
  - 2. To decrease the base value for the passenger-compartment temperature
- 11.6 : Reheat on/off

### Driver's area - setting the air distribution/demisting the windscreen



#### Note:

Precondition: electrical system on.



M83.00-0132-01

- ▶ Turn switch (a) to position 1.

Air flows out: - in the footwell to the right-hand side of the steering column (adjustable), in the footwell on the left-hand side (non-adjustable), at the left-hand side windows, at the right-hand side of the

driver's cab, at the driver's platform and at the instrument panel.

- ▶ Turn switch (a) to position 2.

Air flows out: - in the footwell, at the left-hand side windows, at the right-hand side of the driver's cab, at the driver's platform, at the instrument panel and at the windscreen.



M83.00-0132-01

- ▶ Turn switch (a) to position 3.

Air flows out: at the windscreen and at the instrument panel

## Driver's area - adjusting the temperature

- ▶ Turn switch (a) to position 4 (windscreen demisting).

Air flows out: at the windscreen (for demisting) and at the instrument panel



### Note:

The blower runs at maximum output and cannot be regulated.



### Note:

The following air vents permanently blow air: instrument panel, front right footwell (adjustable), right-hand side of driver's cab.

## Driver's area - adjusting the temperature



### Note:

The temperature in the driver's area is continuously variable.



M83.00-0056-01

- ▶ Turn switch (b) clockwise into the red area.

The temperature in the driver's area is increased.

- ▶ Turn switch (b) anti-clockwise into the blue area.

The temperature in the driver's area is reduced.



### Driver's area - adjusting the blower speed



#### Note:

Precondition: electrical system on, engine running.



#### Note:

The blower speed in the driver's area is continuously variable.



M83.00-0055-01

- ▶ Turn switch (c) clockwise.

The blower speed is increased.



#### Note:

The maximum blower speed is only reached when the engine is running.



#### Note:

In economy mode, the blower only operates at minimum speed if the electrical system is on but the engine is not running.

- ▶ Turn switch (c) anti-clockwise.  
The blower speed is reduced.

## Driver's area - cooling

### Driver's area - cooling



#### Note:

Precondition: engine running, switch b in the blue area, outside temperature above 12 °C.



#### Note:

On buses with the roof-mounted air-conditioning system (observe the version description of the bus), it is only possible to activate driver's area cooling if passenger compartment cooling is also activated.



M83.00-0120-01

- ▶ Press pushbutton (11.2).



#### Note:

The air-conditioning system must be run once per month (including the winter months) to guarantee the tightness of the slide ring seal at the compressor crankshaft.



#### Note:

The maintenance program for the compressor cannot be operated unless the outside temperature is above 0 °C and the coolant temperature (engine circuit) is above 50 °C.

Driver's area cooling control is activated.

The indicator lamp in pushbutton (11.2) lights up.

- ▶ Press pushbutton (11.2) again.

Driver's area cooling control is deactivated.

The indicator lamp in pushbutton (11.2) goes out.

### Additional driver's area ventilation (option)



#### Note:

Precondition: electrical system on.



M83\_00-0753-71

- ▶ Turn rotary knob (1) clockwise to increase blower output.  
The air distribution can now be set using air vents (2).

### Switching air-recirculation mode on and off



#### Note:

Precondition: electrical system on.



M83.00-0121-01

- ▶ Press pushbutton (11.3).  
The indicator lamp in pushbutton (11.3) lights up.  
The roof hatches are closed.  
The fresh-air flaps are closed.  
The roof ventilators switch off.



#### Note:

Air-recirculation mode remains active for approximately 10 minutes. Normal mode is resumed automatically after this time.

- ▶ Press pushbutton (11.3) again.  
The indicator lamp in pushbutton (11.3) goes out.  
The roof hatches are opened.  
The fresh-air flaps are opened.  
The roof ventilators switch on.

## Passenger compartment - switching temperature control on and off - code HH2/HK1

### Passenger compartment - switching temperature control on and off - code HH2/HK1



#### Note:

Precondition: electrical system on, engine running.



#### Note:

With the engine switched off, the economy circuit is active and the roof ventilators remain switched off.



#### Note:

If the electrical system is on but the engine is not running, the blowers operate at no more than minimum output.



#### Note:

Air conditioning of the passenger compartment is only activated if the interior temperature is greater than 22 °C.



M83.00-0122-01

- ▶ Press pushbutton (11.4).

Passenger-compartment temperature regulation is activated.

The indicator lamp in pushbutton (11.4) lights up.



#### Note:

The temperature in the passenger compartment is regulated automatically in line with the outside temperature and the desired temperature set for the passenger compartment.



#### Note:

Blower output is variably increased or reduced and the roof ventilators are switched on or off in line with the temperature in the passenger compartment.

- ▶ Press pushbutton (11.4) again.  
Temperature regulation in the passenger compartment is switched off.  
The indicator lamp in pushbutton (11.4) goes out.

## Passenger compartment – switching temperature regulation on and off



### Note:

All current settings are retained when passenger compartment regulation is switched off. Automatic control is re-activated when passenger compartment regulation is switched on again.

## Passenger compartment – switching temperature regulation on and off



### Note:

Precondition: electrical system on, engine running.



### Note:

With the engine switched off, the economy circuit is active and the roof ventilators remain switched off. If the electrical system is on but the engine is not running, the blowers are switched to speed 1 only. Fresh air is fed into the passenger compartment through the hinged windows and by the roof ventilators.



M83.00-0122-01

- ▶ Press pushbutton (11.4).

Passenger-compartment temperature regulation is activated.

The indicator lamp in pushbutton (11.4) lights up.



### Note:

The temperature in the passenger compartment is regulated automatically in line with the outside temperature and the desired temperature set for the passenger compartment.

## Switching the auxiliary heating on and off



### Note:

Blower output is variably increased or reduced and the roof ventilators are switched on or off in line with the temperature in the passenger compartment.

- ▶ Press pushbutton (11.4) again.

Temperature regulation in the passenger compartment is switched off.

The indicator lamp in pushbutton (11.4) goes out.

## Switching the auxiliary heating on and off



### Note:

Precondition: electrical system on.



### Danger.

Risk of poisoning and asphyxiation. The auxiliary heating must not be used in enclosed spaces such as garages or workshops due to the risk of poisoning and suffocation. Timer and preselection mode are similarly prohibited.



### Danger.

Risk of explosion. The auxiliary heating must be switched off at filling stations and fuel dispensing systems due to the risk of explosion.



### Danger.

Risk of fire. The auxiliary heating must remain switched off in places where ignitable vapours or dust can accumulate (e.g. in the vicinity of filling stations, fuel depots, or coal, sawdust or grain stores or similar).



### Danger.

Risk of fire and burns. There is a risk of fires and burns due to the high exhaust temperatures and the hot exhaust pipe for the auxiliary heating. For this reason, do not stop or park the bus over ignitable materials (e.g. grass) when the auxiliary heating is in operation, has recently been in operation or has been operated by the instant heating button/preset clock.



### Note:

Operation of the auxiliary heating is limited to approximately 30 minutes with the electrical system switched off.



### Note:

The auxiliary heating must be switched on manually. It is not activated automatically.



M83.00-0123-01

- ▶ Press pushbutton (11.5).

The auxiliary heating switches on after approximately 10 to 15 seconds.

The indicator lamp in pushbutton (11.5) lights up.



M54.00-0255-01

The following is shown on the screen: “Auxiliary heating on” (A)



### Note:

Each press of the pushbutton begins an auxiliary heating start-up attempt. The auxiliary heating is electronically locked after 10 unsuccessful start-up attempts.

## Switching the reheat function on and off



### Note:

To unlock the auxiliary heating: switch the on-board power supply off and on.

- ▶ Press pushbutton (11.5) again.

The auxiliary heating system switches off.

The indicator lamp in pushbutton (11.5) goes out.



M54.00-0255-01

The “Auxiliary heating on” indication display (A) on the screen goes out.



### Note:

If the bus is not equipped with an auxiliary heating system, pressing pushbutton (11.5) only switches the recirculation pump for the heating on and off.

The run-on time begins and lasts approximately 90 to 120 seconds.

## Switching the reheat function on and off



### Note:

Precondition: electrical system on, engine running.



### Note:

The recirculated air (i.e. the reduced amount of fresh air) is cooled as it comes into contact with the refrigerant evaporator and reheated by the heat exchanger for the heating system. This process condenses water out of the air passed through the system. Air that is directed to passengers or the driver is therefore dehumidified.



## Passenger-compartment temperature - changing the base value



M83.00-0124-01

- ▶ Press pushbutton (11.6).

Dehumidified air is delivered from the air vents.

The indicator lamp in pushbutton (11.6) lights up.



### Note:

The reheat function remains active for a maximum of approximately 30 minutes.

- ▶ Press pushbutton (11.6) again.  
The reheat function is switched off.  
The air delivered from the air vents is no longer dehumidified.  
The indicator lamp in pushbutton (11.6) goes out.

### Passenger-compartment temperature - changing the base value



### Note:

Precondition: electrical system on.



### Note:

To make it possible to change the temperature in the passenger compartment if necessary, the base value setting can be changed at the control panel. The base value programmed as the default for the temperature in the passenger compartment and assigned to temperature control pushbutton (11.4) is 24 °C. It can be increased to a maximum of 28 °C or reduced to a minimum of 20 °C in increments of 2 °C.

## Passenger-compartment temperature - changing the base value



M83.00-0125-01

- ▶ Press and hold pushbutton (11.4) for at least 10 seconds.

The indicator lamps in pushbuttons (11.3), (11.4) and (11.5) may flash individually or in combination, depending on the base value currently set.



M83.00-0121-01

- ▶ Press pushbutton (11.3).

The base value is increased. Press once = increase by 2 °C. Press twice = increase by 4 °C.



### Note:

The base value can be increased by a maximum of 4 °C.



M83.00-0123-01

- ▶ Press pushbutton (11.5).

The base value is decreased. Press once = decrease by 2 °C. Press twice = decrease by 4 °C.



### Note:

The base value can be decreased by a maximum of 4 °C.

## Passenger-compartment temperature - changing the base value



M83.00-0122-01

- ▶ Press pushbutton (11.4) again.
- Adjustment of the base value is confirmed.
- The indicator lamps stop flashing.
- The control unit switches back to normal operation.



M83.00-0123-01

The following base value settings are possible: base value setting 20 °C. The indicator lamp in pushbutton (11.5) flashes.



M83.00-0126-01

Base value setting 22 °C. The indicator lamps in pushbuttons (11.4) and (11.5) flash.

## Passenger-compartment temperature - changing the base value



M83.00-0122-01

Base value setting 24 °C. The indicator lamp in pushbutton (11.4) flashes.



### Note:

Temperature control pushbutton (11.4) is programmed with a default value of 24 °C.



M83.00-0127-01

Base value setting 26 °C. The indicator lamps in pushbuttons (11.3) and (11.4) flash.



M83.00-0121-01

Base value setting 28 °C. The indicator lamp in pushbutton (11.3) flashes.

### Opening the roof hatches

**Note:**

Precondition: electrical system on, temperature control off, windscreen wipers off.



M54\_00-1212-71

- ▶ Press the upper section of pushbutton (5).

The roof hatches are raised at the rear (air-out position).



**Note:**

The red indicator lamp in the pushbutton lights up.

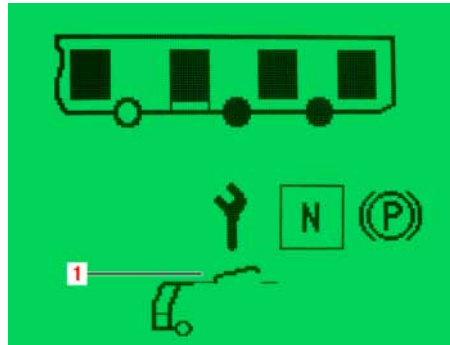

M68\_00-0235-71

- ▶ The roof hatches are indicated on the display screen as being in the air-out position.

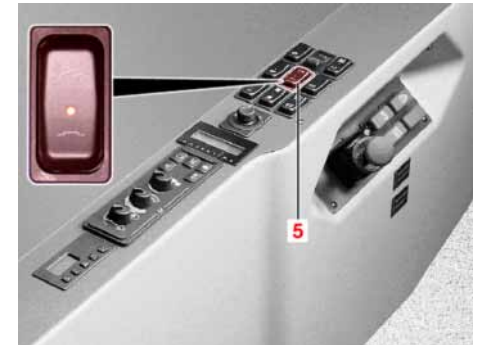

M54\_00-1212-71

- ▶ Press the upper section of pushbutton (5) again.

The roof hatches are raised at the front and rear.

## Opening the roof hatches

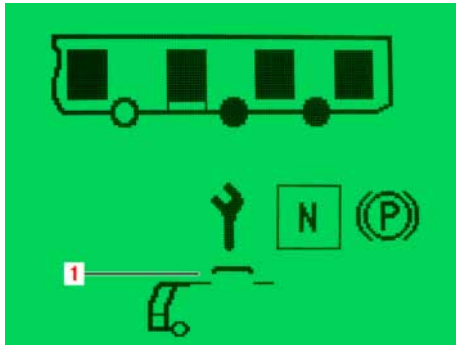

M68\_00-0236-71

- ▶ The roof hatches are indicated on the display screen as being in the open position.



M54\_00-1212-71

- ▶ Press the upper section of pushbutton (5) again.  
The roof hatches are raised at the front (air-in position).

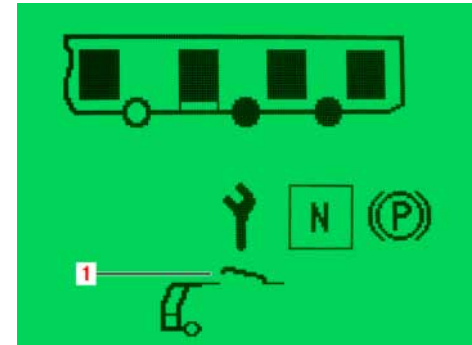

M68\_00-0237-71

- ▶ The roof hatches are indicated on the display screen as being in the air-in position.

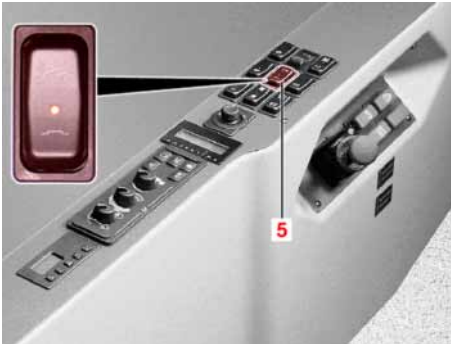

M54\_00-1212-71

- ▶ Press the upper section of pushbutton (5) again.

The roof hatches close. The red indicator lamp in the pushbutton goes out.



### Note:

It is possible to close the roof hatches at any time by pressing the lower section of pushbutton (5).



### Note:

The roof hatches close automatically when the temperature control or wind-screen wipers are switched on.



### Note:

The roof hatches close automatically when the ignition is switched off.

- ▶ To prevent forced closing when the ignition is switched off, it is necessary to press and hold button (5) while the engine is switching off.

The roof hatches remain open (air-out position) and the red indicator lamp in pushbutton (5) lights up.

## Fans on/off



### Note:

Precondition: engine running.



### Note:

Automatic fan switch on/off is activated whenever the engine is started.

## Switching fans on and off - code HH2/HK1

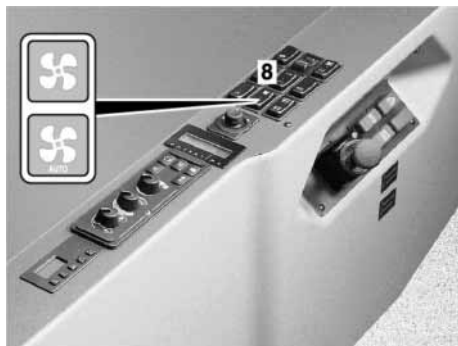

M54.00-0225-01

- ▶ Press the upper section of pushbutton (8).

The fans start to run.

The indicator lamp in pushbutton (8) lights up.



### Note:

The fans start up automatically if: - the interior temperature is too high (above approximately 22 °C) - air-recirculation control is switched off

- ▶ Press the lower section of pushbutton (8).

Fans switch off.

The indicator lamp in pushbutton (8) goes out.



### Note:

The fans automatically switch off when: - the interior temperature is too low - air-recirculation mode is switched on

Automatic fan activation and deactivation mode is reactivated.

## Switching fans on and off - code HH2/HK1



### Note:

Precondition: engine on.



### Note:

Automatic fan switch on/off is activated whenever the engine is started.



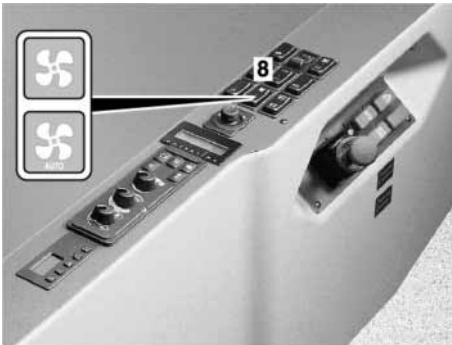

M54.00-0225-01

- ▶ Press the upper section of pushbutton (8).

The fans start to run.

The indicator lamp in pushbutton (8) lights up.



### Note:

The fans start up automatically if: – the output of the interior blowers rises to approximately 70 %. – air-recirculation mode is not active.

- ▶ Press the lower section of pushbutton (8).

Fans switch off.

The indicator lamp in pushbutton (8) goes out.



### Note:

The fans automatically switch off when:  
– the output of the interior blowers falls below approximately 62 %.  
– air-recirculation control is active.  
– automatic passenger compartment regulation is not active.

## Auxiliary heating digital timer (option)

Auxiliary heating digital timer  
(option)

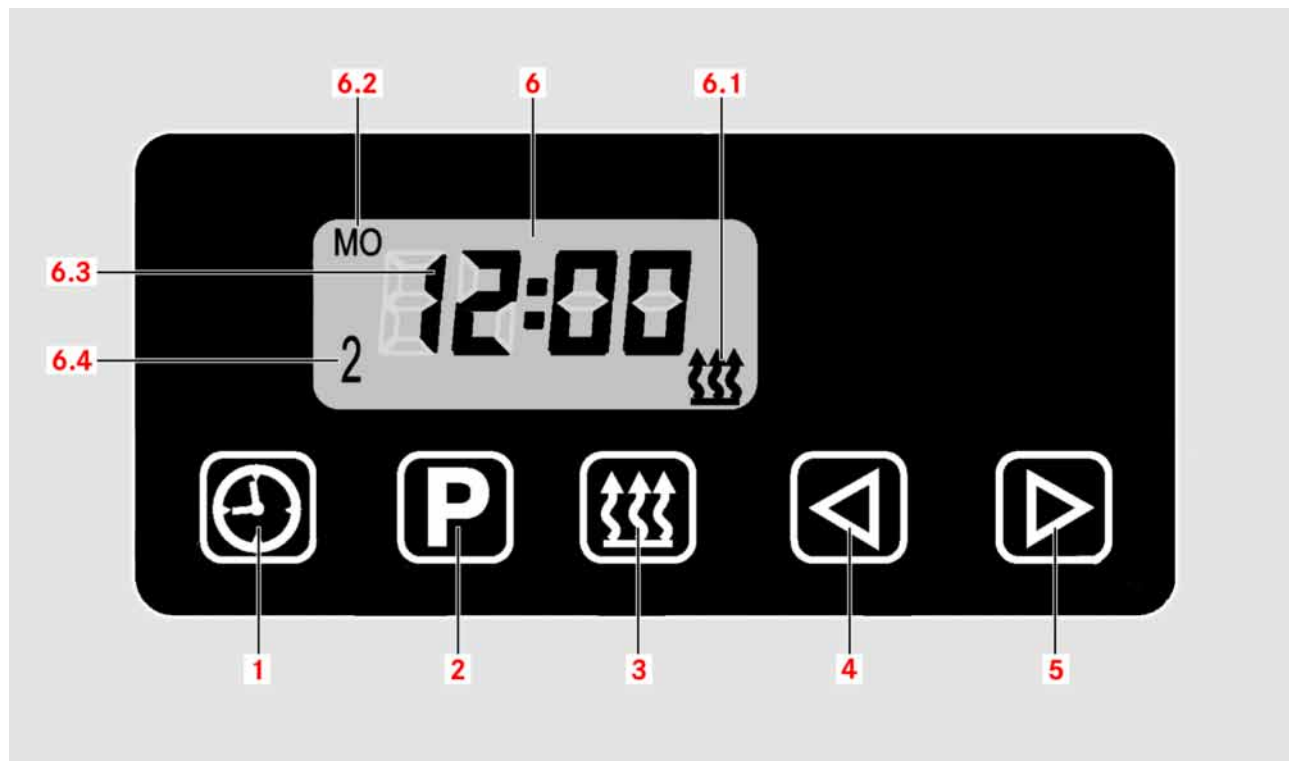

## Auxiliary heating operation (option)

- 1 Time button: Display time/set time (press for longer than 2 seconds)
- 2 Program selection: Heating start preset time: display, set, delete
- 3 Instant heating: Switch auxiliary heating on and off manually
- 4 Back
- 5 Forward
- 6 Screen display
- 6.1 Operating display
- 6.2 Weekday
- 6.3 Time display
- 6.4 Storage location

### Auxiliary heating operation (option)



#### **Danger.**

Risk of explosion and suffocation. Heater operation is not permitted: at filling stations or fuel dispensing systems, in places where ignitable vapours or dust can accumulate (e.g. in the vicinity of filling stations, fuel depots, or coal, sawdust or grain stores), in enclosed spaces (e.g. bus depot).



#### **Caution:**

The heater must be operated at least once a month, with the engine cold, for at least 10 minutes



#### **Note:**

The timer can be used to preset the heating start time for a period of up to seven days. It is possible to program three switch-on times, although only one can be activated. The clock displays the current time and the weekday when the ignition switch is switched on. The display and

buttons are lit when the heater is in operation. All symbols flash in the indication display after the power supply is connected. The time and the weekday must be set.



#### **Note:**

If the ignition switch is switched off and the heating unit is in continuous heating mode, a remaining time of 15 minutes appears in the display and the heating unit continues to operate.

## Auxiliary heating operation (option)

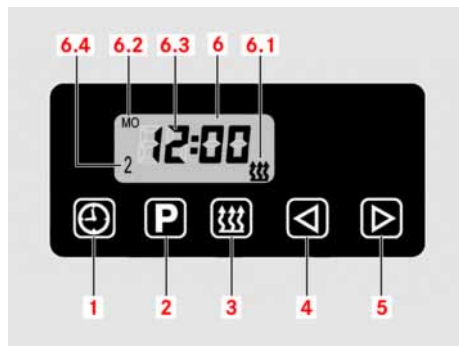

M83\_00-0730-71

- ▶ Control of the clock was designed in such a way that all flashing symbols can be adjusted using buttons (4) and (5). The displayed time is stored if 5 seconds pass without a switch being pressed. Fast mode is enabled when buttons (4) and (5) are pressed down for longer than 2 seconds.

- ▶ Switch on the auxiliary heating with digital timer: press button (3).

The auxiliary heating is switched on manually.

- ▶ Switch off the auxiliary heating: press button (3) again.

The auxiliary heating is switched off manually.

- ▶ Call up the time with the ignition switched off: press button (1).
- ▶ Set the time or day: press down button (1) for longer than 2 seconds

Time (6.3) flashes.

- ▶ Adjust the time with buttons (4) and (5).

Now the weekday (6.2) flashes, it can be adjusted with buttons (4) and (5).

- ▶ Program the start of heating (preset time): press button (2).

Storage location 1 (6.4) flashes.

- ▶ Adjust the time with buttons (4) and (5).

Weekday (6.2) flashes.

- ▶ Adjust the weekday with buttons (4) and (5).

Time (6.3) flashes.



### Note:

Storage locations 2 and 3 (6.4) can be adjusted using the same procedure by repeatedly pressing button (2).

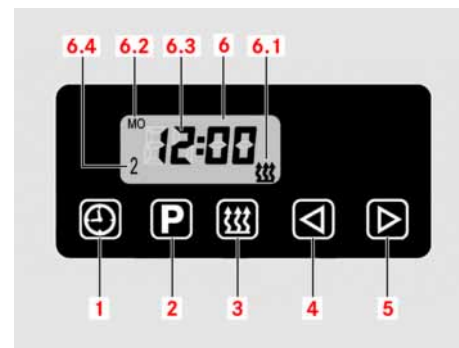

M83\_00-0730-71

- ▶ Display preset times: repeatedly press button (2) until the required storage location is displayed.

- ▶ Deactivate the preset time: press button (2) repeatedly until the time is displayed without a storage location (6.4).
- ▶ Program the switch-on duration: the heater must be OFF. Press down button (4) for three seconds.  
Switch-on duration flashes
- ▶ Set the desired switch-on duration using buttons (4) and (5).



**Note:**

The switch-on duration can be set between 10 and 120 minutes.

- ▶ Adjust remaining time: set the desired remaining time using buttons (4) and (5).



**Note:**

The remaining time is the time for which the heater remains in operation. It can only be changed when the heating unit is operating and the ignition switch is off.



**Note:**

The remaining time can be set between 10 and 120 minutes.



|  |            |
|--|------------|
| <b>General Information / Safety Information</b> .....          | <b>190</b> |
| <b>Emergency operation - doors</b> .....                       | <b>192</b> |
| <b>Opening/closing door 1 from the outside</b> .....           | <b>194</b> |
| <b>Locking/unlocking door leaves from the outside</b> .....    | <b>195</b> |
| <b>Opening/closing door 1 from the outside</b> .....           | <b>195</b> |
| <b>Opening/closing door 1 from the outside</b> .....           | <b>196</b> |
| <b>Locking door 1 with the key (option)</b> .....              | <b>197</b> |
| <b>Locking/unlocking the door leaves from the inside</b> ..... | <b>197</b> |
| <b>Opening/closing the doors from the inside</b> .....         | <b>198</b> |
| <b>Opening/closing automatic doors from the inside</b> .....   | <b>199</b> |
| <b>Opening/closing automatic doors from the outside</b> .....  | <b>201</b> |
| <b>Opening/closing automatic doors</b> .....                   | <b>203</b> |

### General Information / Safety Information

#### Protection against entrapment in the door opening direction



M54\_00-1300-71

If a door makes contact with an object when opening, the door leaf concerned is switched to reduced-power pushback. The indicator lamp in the pushbutton pressed (1 / 2 / 3 / 4) flashes. The door then continues to move in the opening direction.

#### Protection against entrapment in the door closing direction



M54\_00-1300-71

If a door makes contact with an object when closing, the closing motion is reversed to open the door again.

The indicator lamp in the pushbutton pressed (1 / 2 / 3 / 4) lights up.

On automatic doors, the closing movement is reinitiated after the hold-open time has elapsed.





#### Emergency operation - doors

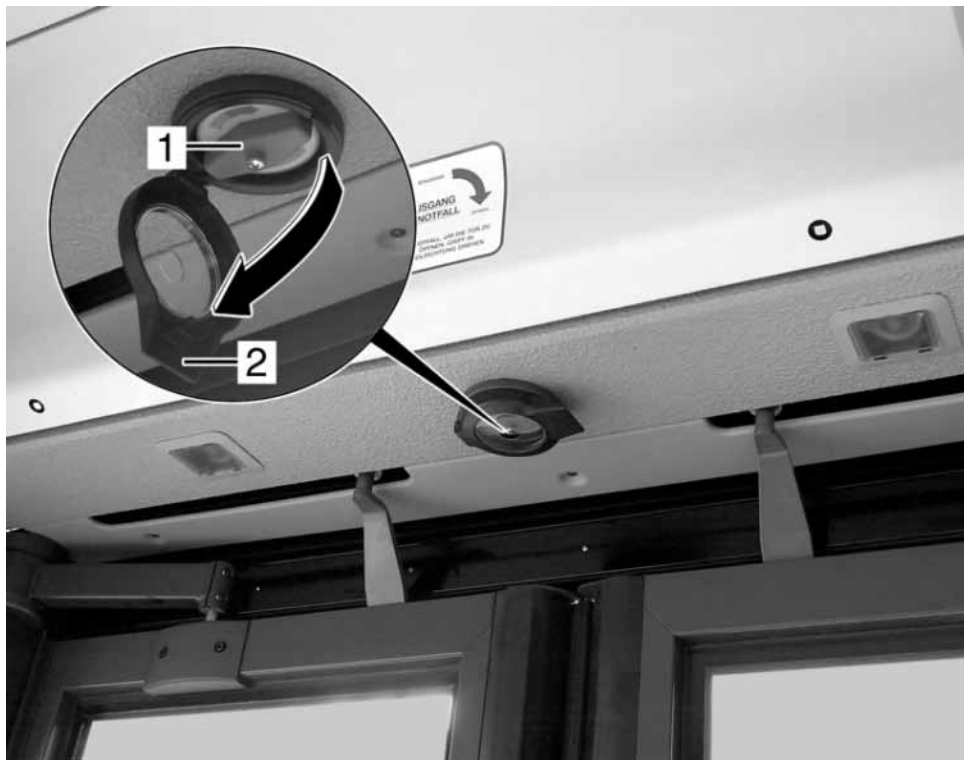

## Emergency switch location

**Danger.**

Risk of accident. Only use the emergency switch in emergencies.

**Note:**

There is one interior and one exterior emergency switch at each of the doors.

**Note:**

Observe the laws and regulations in all countries concerned.

- 1 Emergency switch
  - in drive position, when the red handle strip on the emergency switch is parallel to the direction of travel,
  - in emergency position, when the red handle strip on the emergency switch is turned 90° relative to the direction of travel.

- 2 Emergency switch cover:
  - Open cover (2) before operating emergency switch (1).
  - Opening the doors in an emergency: Turn the emergency switch in the direction of the arrow from the drive position to the emergency position. The door leaves can be opened manually.

**Note:**

Warning functions when the electrical system is switched on: the red warning lamp lights up. The “Emergency switch operated” malfunction display is shown on the screen. A signal sounds. The corresponding door pushbutton on the instrument panel flashes.

**Note:**

Exterior emergency switch (1) next to the doors makes it possible for rescuers to gain access to the vehicle interior from the outside in the event of an emergency or an accident.

**Danger.**

All doors must be unlocked before the bus is driven. It may otherwise not be possible to open the doors urgently from the outside in an emergency.

**Note:**

The doors must be relocked when the vehicle is parked to prevent unauthorised access to the vehicle interior.

### Opening/closing door 1 from the outside

Close the doors: Turn the emergency switch in the opposite direction to the arrow from the emergency position to the drive position.



#### Note:

The warning functions are deactivated if the corresponding door pushbutton on the instrument panel is pressed and there is sufficient reservoir pressure.

### Opening/closing door 1 from the outside



#### Note:

Precondition: battery voltage  $24 \pm 3$  volts.

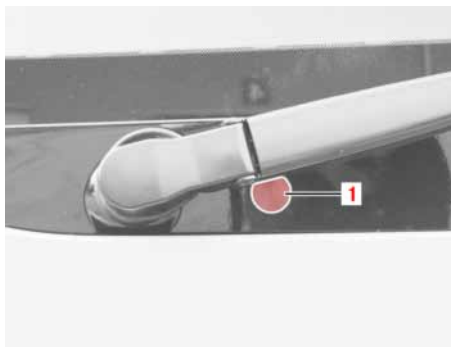

M72\_00-0262-71

- ▶ To open door 1, press pushbutton (1) firmly and precisely in the centre (pressure point).



#### Note:

If pushbutton (1) is pressed in an area away from the centre, door 1 does not open. This is designed to prevent unauthorised persons from opening the doors.



#### Note:

Door 1 does not open if it has been mechanically locked.

- ▶ To close door 1, press pushbutton (1) firmly and precisely in the centre (pressure point).

## Locking/unlocking door leaves from the outside

### Locking/unlocking door leaves from the outside



**Note:**

All door leaves must be unlocked before the bus is driven.



M72.00-0024-01

- ▶ Turn lock (3) upwards (4) with square key (1).

Lock indicator (2) is black. The door leaf is locked.

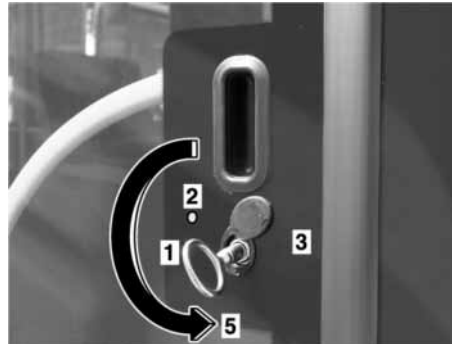

M72.00-0025-01

- ▶ Turn lock (3) downwards (5) with square key (1).

Lock indicator (2) is green. The door leaf is unlocked.

### Opening/closing door 1 from the outside



**Note:**

Precondition: battery voltage  $24 \pm 3$  volts.

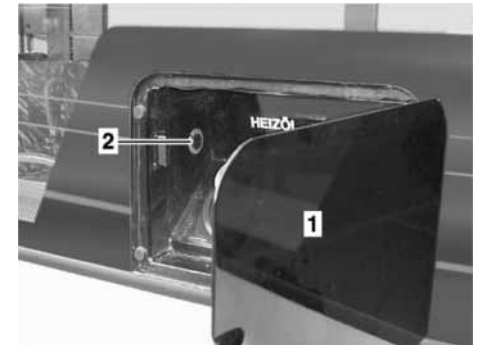

M72.00-0028-01

- ▶ Open fuel filler flap (1).
- ▶ Press pushbutton (2).

Keep pushbutton (2) pressed until door 1 opens.

### Opening/closing door 1 from the outside



#### Note:

The way in which pushbutton (2) is operated may differ from the method described here depending on customer options.

- ▶ Press pushbutton (2).  
Keep pushbutton (2) pressed until door 1 closes.

### Opening/closing door 1 from the outside



#### Note:

Precondition: battery voltage  $24 \pm 3$  volts.

- ▶ Open the front flap above the right-hand headlamp.



M72.00-0027-01

- ▶ Press pushbutton (2).  
Keep pushbutton (2) pressed until door 1 opens.



#### Note:

The way in which pushbutton (2) is operated may differ from the method described here depending on customer options.

- ▶ Press pushbutton (2).  
Keep pushbutton (2) pressed until door 1 closes.

## Locking door 1 with the key (option)

## Locking door 1 with the key (option)

- ▶ When you disembark, lock door 1 from the outside using the key.

**Note:**

If the locked door was unlocked from the inside using the handwheel, the door cannot be locked from the outside again until the unlocking mechanism has been enabled.



M72\_00-0399-71

- ▶ To do this, using a long, pointed object (e.g. a screwdriver), operate the unlocking mechanism through opening (1) and simultaneously turn the handwheel in the opposite direction to the printed arrow.

The door can now be locked from the outside using the key again.

## Locking/unlocking the door leaves from the inside

**Note:**

All door leaves must be unlocked before the bus is driven.

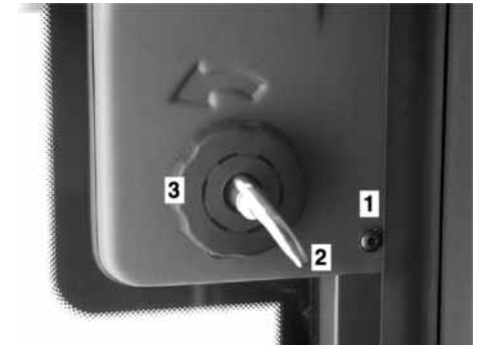

M72.00.0026-01

- ▶ Turn lock (1) with square key (2) in the opposite direction to the arrow. The door is locked.

### Opening/closing the doors from the inside



#### Note:

Square key (2) is the only means of locking the door leaf.

- ▶ Turn lock (1) in the direction of the arrow using square key (2) or handwheel (3).

The door is unlocked.



#### Note:

Handwheel (3) is able only to unlock the door leaf.

### Opening/closing the doors from the inside



#### Note:

Precondition: bus stationary, electrical system on.



#### Danger.

Do not drive the bus unless the doors are properly closed.



M54\_00-1300-71

- ▶ Press one of pushbuttons (1) to (3).  
The relevant door(s) open(s).  
The indicator lamp in the pushbutton pressed lights up.



## Opening/closing automatic doors from the inside

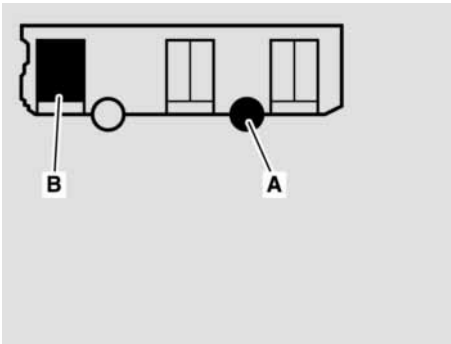

M54.00-0235-01

The following is shown on the screen:  
 “Drive-off lock/bus stop brake activated” (A). “Door 1 and/or door 2, 3 open” (B).

- ▶ Press one of pushbuttons (1) to (3) again.

The relevant door closes.

The indicator lamp in the pushbutton pressed goes out.

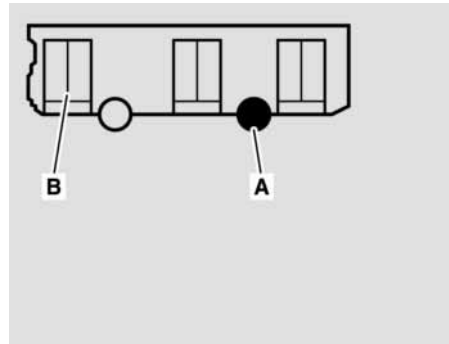

M54.00-0244-01

The following is shown on the screen:  
 “Drive-off lock/bus stop brake activated” (A). “All doors closed” (B).

The bus is ready to depart.



### Note:

The drive-off lock is released as soon as the accelerator pedal is depressed and it is possible to pull away.

### Opening/closing automatic doors from the inside



#### Note:

Precondition: electrical system on, all doors unlocked.



#### Danger.

Open doors increase the risk of accident for passengers. Do not drive the bus unless the doors are properly closed. The door enable switch is intended to be used to enable the doors for opening only at bus stops and with the bus stationary.

### Opening/closing automatic doors from the inside

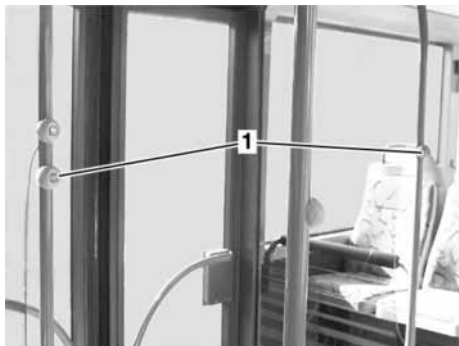

M72.00-0034-01

- ▶ Passenger: press pushbuttons (1) next to the doors.  
A signal sounds.



M82.00-0005-01

The “Bus stopping” or “Stop” passenger information lights up.



M54.00-0253-01

The following is shown on the screen:  
“Stop request” (C) (flashing).

## Opening/closing automatic doors from the outside



M54\_00-1301-71

- ▶ Driver: press switch (1) to the right.  
The door opens automatically when switch (1) is pressed.



### Note:

The door closes automatically after a hold-open time of approximately 3 seconds. The door can then be reopened by the passenger as often as desired while door enable switch (1) is pressed.

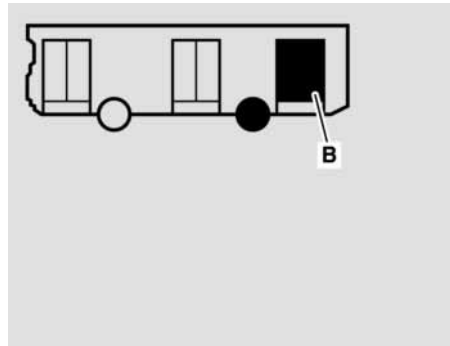

M54.00-0247-01

The following is shown on the screen: “Door open” (B) (door 3 in the example).

### Opening/closing automatic doors from the outside



### Note:

Precondition: electrical system on, all doors unlocked.



### Danger.

Open doors increase the risk of accident for passengers. Do not drive the bus unless the doors are properly closed. The door enable switch is intended to be used to enable the doors for opening only at bus stops and with the bus stationary.

## Opening/locking

### Opening/closing automatic doors from the outside



M54\_00-1301-71

- ▶ Driver: press door enable switch (1) to the right.

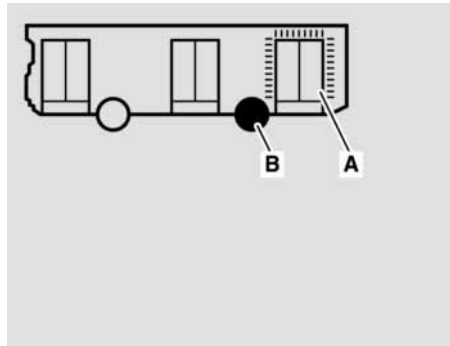

M54.00-0248-01

The following is shown on the screen: “Door enabled” (A) (door 3 in the example) and “Drive-off lock active” (B).

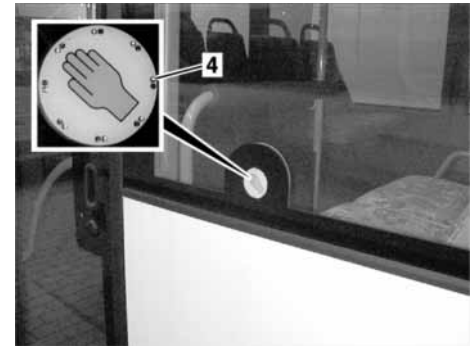

M72.00-0035-01

- ▶ Passenger: press pushbutton (4).  
The door opens.  
The indicator lamp in the relevant door pushbutton in the driver's area lights up.

## Opening/closing automatic doors

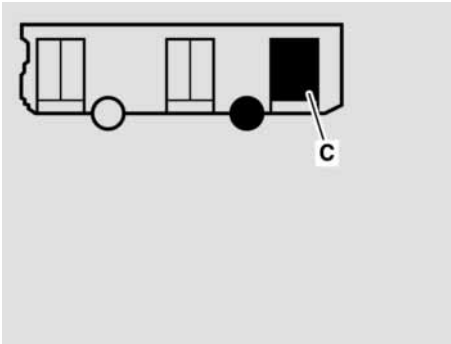

M54.00-0249-01

The following is shown on the screen:  
“Door open” (C) (door 3 in the example).



### Note:

The red indicator lamps in the exterior or pushbutton light up briefly if exterior “Open door” pushbutton (4) is pressed.



### Note:

The door closes automatically after a hold-open time of approximately 3 seconds.



### Note:

The door can be opened as often as desired as long as the driver is pressing the door enable switch (1).

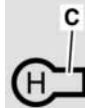

M54.00-0253-01

The “Stop request” indication display (C) on the screen goes out.

## Opening/closing automatic doors



### Note:

Precondition: electrical system on, all doors unlocked.



### Danger.

Open doors increase the risk of accident for passengers. Do not drive the bus unless the doors are properly closed. The door enable switch is intended to be used to enable the doors for opening only at bus stops and with the bus stationary.

### Opening/closing automatic doors



M72.00-0036-01

- ▶ Press pushbuttons (1) next to the doors.

A signal sounds.



M82.00-0005-01

The “Bus stopping” or “Stop” passenger information lights up.



M54.00-0253-01

The following is shown on the screen: “Stop request” (C) (flashing).



M54\_00-1301-71

- ▶ Driver: press door enable switch (1) to the right.

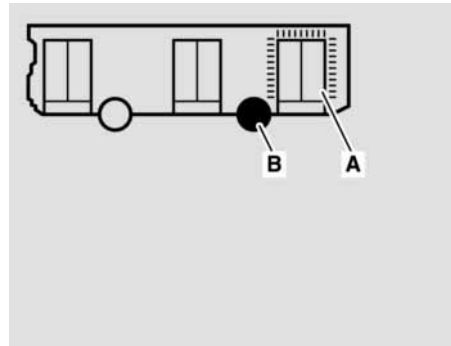

M54.00-0248-01

The following is shown on the screen: “Door enabled” (A) (door 3 in the example) and “Drive-off lock active” (B).

DOOR OPEN is displayed in pushbutton (1) next to the doors.

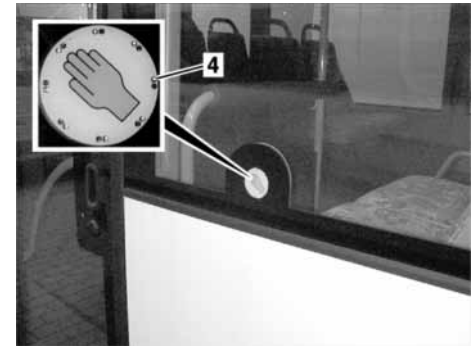

M72.00-0035-01

- ▶ Exterior pushbuttons (4) are activated and the green indicator lamps in pushbutton (4) light up (see example).
- ▶ Passenger: press pushbutton (1) or (4).  
The door opens.  
The indicator lamp in corresponding door pushbutton (1 to 4) lights up.

### Opening/closing automatic doors

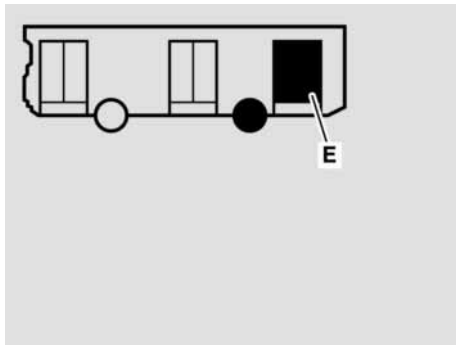

M54.00-0251-01

The following is shown on the screen:  
“Door open” (E) (door 3 in the example).



#### Note:

If pushbutton (4) is pressed, the red indicator lamps in the pushbutton light up briefly.



#### Note:

The door closes automatically after a hold-open time of approximately 3 seconds.



#### Note:

The door can be opened as often as desired as long as door enable switch (1) remains pressed.

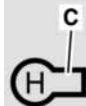

M54.00-0253-01

The “Stop request” indication display (C) on the screen goes out.



|  |            |
|--|------------|
| <b>General Information / Safety Information</b> .....                  | <b>210</b> |
| <b>Engine oil level: oil level information on the screen</b> .....     | <b>210</b> |
| <b>General Information / Safety Information</b> .....                  | <b>213</b> |
| <b>Operating safety and roadworthiness</b> .....                       | <b>217</b> |
| <b>Tyre pressure</b> .....   | <b>217</b> |
| <b>Tyre tread</b> .....  | <b>218</b> |
| <b>Tyre condition</b> .....  | <b>218</b> |
| <b>Tyre age</b> .....  | <b>218</b> |
| <b>Invisible tyre damage</b> .....                                     | <b>219</b> |
| <b>Tyre load capacity, top speed of tyres and types of tyres</b> ..... | <b>219</b> |
| <b>Retreaded tyres</b> .....   | <b>220</b> |
| <b>Cleaning the tyres</b> .....  | <b>220</b> |
| <b>Retightening the wheel nuts</b> .....                               | <b>220</b> |
| <b>Wheel nut tightening torques</b> .....                              | <b>221</b> |
| <b>Snow chains</b> .....   | <b>221</b> |
| <b>Tyre air pressure chart.</b> .....                                  | <b>224</b> |

**Table of contents**

|   |            |
|---|------------|
| <b>Safety measures to be taken in the event of a flat tyre or a wheel change</b> .....                          | <b>226</b> |
| <b>Jacking points</b> .....   | <b>226</b> |
| <b>Safety measures to be taken in the event of a flat tyre or a wheel change</b> .....                          | <b>228</b> |
| <b>Jacking points, front</b> .....  | <b>228</b> |
| <b>Jacking points, centre (CONECTO G)</b> .....   | <b>229</b> |
| <b>Jacking points, rear</b> .....   | <b>229</b> |
| <b>Emergency release of the drive-off lock</b> .....  | <b>230</b> |
| <b>Parking brake emergency release (option)</b> .....   | <b>231</b> |
| <b>Electrical system safety precautions</b> .....   | <b>232</b> |
| <b>General safety precautions for batteries</b> .....   | <b>233</b> |
| <b>Safety precautions for handling batteries</b> .....  | <b>233</b> |
| <b>Battery maintenance</b> .....  | <b>234</b> |
| <b>Recharging the batteries</b> .....   | <b>235</b> |
| <b>Working on the electrical system and electrical fuses</b> .....  | <b>235</b> |
| <b>Measures required for the prevention of damage to buses or components during electric welding work</b> ..... | <b>236</b> |

|  |            |
|--|------------|
| <b>Switching the on-board power supply on/off</b> .....                            | <b>237</b> |
| <b>Switching off the on-board power supply at the master safety switch</b> .....   | <b>238</b> |
| <b>Jump-starting where vehicle batteries are located one above the other</b> ..... | <b>239</b> |
| <b>Jump-starting where vehicle batteries are mounted side by side</b> .....        | <b>242</b> |
| <b>Jump-starting a bus fitted with a battery charging socket</b> .....             | <b>244</b> |
| <b>Opening the emergency exit in the roof</b> .....                                | <b>245</b> |
| <b>Note on maintenance work</b> .....  | <b>247</b> |
| <b>Cleaning the underbody</b> .....  | <b>247</b> |

#### General Information / Safety Information

#### Safety instructions for working in the engine compartment



#### Danger.

Never leave the engine running when work is being carried out in the engine compartment.



#### Danger.

Safeguard the engine against being switched on without authorisation. Remove the key from the ignition switch.



#### Danger.

If the engine is at normal operating temperature, allow it to cool down for some time - risk of burning.

Should it be necessary to change a drive belt as the result of a breakdown and no

suitable gauge is available to check the belt tension then the bus must be taken to the nearest EvoBus Service Partner as soon as possible to check that the belt tension and the tightening torques are correct.

#### Engine oil level: oil level information on the screen



M54\_00-1334-71

The various items of oil level information on the screen are operating displays and are not displayed automatically. The only way to call them up is by pressing “Screen control” pushbutton (1) (upper section).



**Caution:**

There is a risk of engine damage if the oil level is too low or too high. Therefore, correct the oil level as soon as possible.



**Danger.**

Risk of accident. Calling up additional information manually while the vehicle is in motion would divert your attention away from the road and traffic conditions. This could result in an accident with serious or fatal injuries. For this reason, do not call up information manually unless the bus is stationary and the parking brake is applied.



**Note:**

Observe “Calling up/selecting/permanently displaying operating displays” in section 00.

**Engine oil level OK**

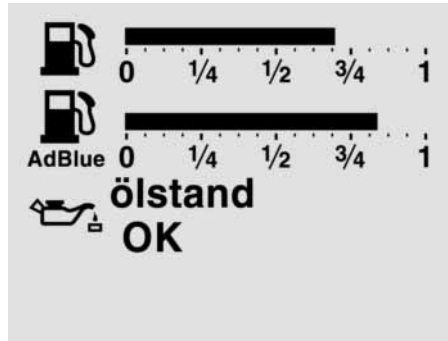

M54\_00-1132-01

The “Oil level OK” message indicates that the oil level is in the normal range.



**Note:**

If the oil level is OK, it is not possible to call up any further oil level information.

**Engine oil level too low**

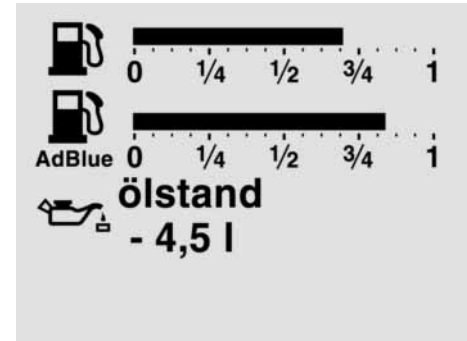

M54\_00-1134-01

An insufficient engine oil level is indicated by the “Oil level” message and the top-up amount required in litres (4.5 litres in the example).



**Note:**

This display is only available if a yellow warning level malfunction or the “Message available” symbol (spanner) has previously been displayed.

### Engine oil level: oil level information on the screen



#### Note:

There is a risk of engine damage if the engine oil level is too low. Therefore, correct the oil level as soon as possible.



#### Note:

Refer to “Malfunction displays” in section 00.

#### Engine oil level too high

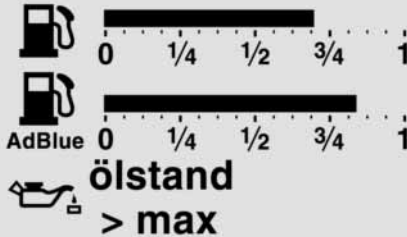

M54\_00-1135-01

The engine oil level is too high if the “Oil level > max” message is displayed.



#### Note:

This display is only available if a yellow warning level malfunction has previously been displayed.



#### Note:

There is a risk of engine damage if the engine oil level is too high. Therefore, correct the oil level as soon as possible.

#### Engine oil level cannot be measured

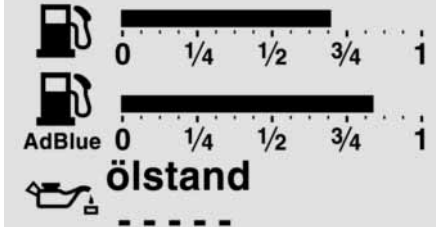

M54\_00-1136-01

If the oil level cannot be measured, e.g. due to a sensor fault, this is indicated by the “Oil level - - - -” message.

General Information / Safety Information

Operating safety and roadworthiness

Tyres are particularly important for the operating safety and roadworthiness of the bus. The pressure, tread and condition of the tyres should therefore be checked on a regular basis.

Tyre pressure

Check the specified tyre pressure regularly – at least once a week and before longer journeys – when the tyres are cold.



**Danger.**

Always observe the specified tyre pressures for your bus. The temperature and pressure of the tyres increase when the bus is in motion. For this reason, you should never reduce the pressure of warm tyres. The tyre pressures would then be too low once the tyres had cooled. If the tyre air pressure is too low, the tyre is liable to burst, particularly with increasing

numbers of passengers/load and speed. This could result in you losing control of your bus and causing an accident, thereby injuring yourself and other people.



**Note:**

If the tyre pressure is too low, this leads to intensive heating of the tyres, increased tyre wear, changes in directional stability and increased fuel consumption.



**Note:**

If the tyre pressure is too high, this results in a longer braking distance, poorer tyre grip and increased tyre wear.



**Caution:**

Caps on the tyre valves protect the valve inserts from moisture and dirt. The caps on the tyre valves should therefore always be screwed on tightly.

Tyre tread

A minimum tyre tread depth is specified by law. Comply with the legal specifications for the relevant country.

As the remaining tread depth reduces, the less effective the road grip and handling characteristics of the bus become, particularly on wet or snowy roads.

In the interest of safety, have the tyres replaced before the legally-specified minimum tread depth is reached.



**Danger.**

Always ensure that there is sufficient tyre tread. Insufficient tyre tread depth increases the risk of aquaplaning if the bus is driven at high speed during heavy rain or in slush. The tyre tread can no longer deflect the water away. This could result in you losing control of your bus and causing an accident, thereby injuring yourself and other people.

#### Tyre condition

Before setting off, check the tyres on the bus for:

- external signs of damage
- foreign objects in the tyre tread
- foreign objects between twin tyres
- cracks, bulges



#### Note:

Please note that cracks, bulges or external damage can cause a tyre to burst. This could result in you losing control of the bus and causing an accident, thereby injuring yourself and other people. Have damaged tyres replaced immediately.

#### Tyre age

Have the tyres changed at least every six years, irrespective of wear. This also applies for the spare wheel.



#### Danger.

The sun's rays and environmental factors cause tyres to age. The rubber from which the tyre is made loses elasticity. Tyres harden and become brittle, cracks appear due to ageing. Tyres which are more than six years old are no longer reliable.

#### Invisible tyre damage

Avoid crushing tyres against the kerb or switching off the bus when a part of the tyre tread is up on the kerb.



#### Danger.

Driving over the edge of the kerb or sharp edged objects can cause damage to the tyre substructure which is not visible externally. Damage to the tyre substructure only becomes noticeable much later and could cause the tyre to burst. This could result in you losing control of your bus and causing an accident, thereby injuring yourself and other people.

#### Tyre load capacity, top speed of tyres and types of tyres



#### Danger.

Exceeding the specified tyre load capacity or the approved maximum tyre speed could lead to tyre damage or tyre failure. This could result in you losing control of your bus and causing an accident, thereby injuring yourself and other people. For this reason, only use the approved tyre types and sizes for your bus model and note the required tyre load capacity and speed index for your bus. Pay particular attention to country-specific tyre approval regulations. These regulations may specify a particular type of tyre for your bus or prohibit the use of particular tyre types that may be approved in other countries. In addition, it may be advisable to use a specific type of tyre in certain regions or areas of use. You can obtain information on tyres from any EvoBus Service Partner.

Where twin tyres are fitted, the twin tyres must have the same external diameter, otherwise the tyre that has the



largest diameter will be overloaded. Tip: the simplest and most reliable measurement method is to check circumferences using a circumference tape.



**Note:**

The maximum tolerance for twin tyres is 0.5% of the tyre diameter. The larger tyre must always be fitted in the outboard position.

**Retreaded tyres**

Retreaded tyres are not inspected for EvoBus and are therefore not recommended. Existing damage is not always detected during retreading. For this reason, EvoBus cannot guarantee the safety of the bus if retreaded tyres are used.

**Cleaning the tyres**



**Danger.**

Risk of accident. Clean tyres and suspension air bags very carefully. Round-spray jets must not be used to clean the tyres and suspension air bags. The water jet may damage the tyres. Replace damaged tyres.



**Environmental protection**

Damage to the environment: only clean the bus at a washpoint intended for this purpose. Heed environmental protection measures.

**Retightening the wheel nuts**



**Danger.**

Risk of accident. Regularly check the wheel nuts for firm seating and retighten if necessary. Make sure that the wheel nuts on a new or changed wheel are retightened after driving for 30 miles (approximately 50 km). If new or newly lacquered wheel rims are used you must

also retighten the wheel nuts after the bus has driven for 600 to 3,000 miles (approximately 1,000 to 5,000 km). Observe the tightening torques.

**Wheel nut tightening torques**

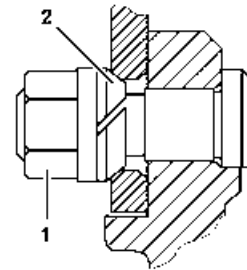

M40\_10-0001-01



**Danger.**

Risk of accident. Observe the tightening torques: pressed-steel wheel with centring by spherical spring washers (2) and wheel bolts 450 Nm.

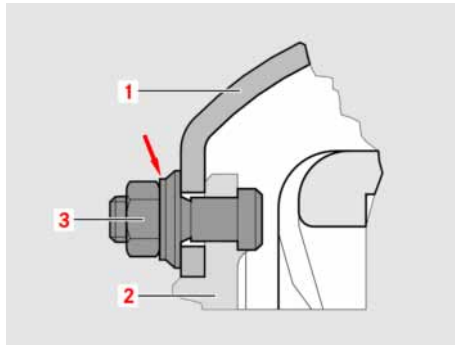

M40.00-0016-01



#### **Danger.**

Risk of accident. Observe the tightening torques: pressed-steel wheel with hub centring by wheel hub 600 Nm. Light-alloy wheel with hub centring 600 Nm.

#### **Snow chains**

Snow chains



#### **Caution:**

Snow chains must not be used on the wheels of the front axle.



#### **Note:**

Comply with the manufacturer's fitting instructions and legal requirements.



#### **Note:**

Only fine-link snow chains are permitted.



#### **Note:**

Raising the bus using the raising/lowering system may make it easier to fit the snow chains.



#### **Danger.**

Make sure that the snow chains are fitted tightly. Do not exceed the permitted maximum speed of 25 mph (40 km/h).



#### **Note:**

Check that the snow chains are seated firmly after driving for a suitable distance (dependent upon the conditions), retighten if necessary.

### Operating safety and roadworthiness

Tyres are particularly important for the operating safety and roadworthiness of the bus. The pressure, tread and condition of the tyres should therefore be checked on a regular basis.

#### Tyre pressure

Check the specified tyre pressure regularly – at least once a week and before longer journeys – when the tyres are cold.



#### **Danger.**

Always observe the specified tyre pressures for your bus. The temperature and pressure of the tyres increase when the bus is in motion. For this reason, you should never reduce the pressure of warm tyres. The tyre pressures would then be too low once the tyres had cooled. If the tyre air pressure is too low, the tyre is liable to burst, particularly with increasing numbers of passengers/load and speed. This could result in you losing control of your bus and causing an accident, thereby injuring yourself and other people.



#### **Note:**

If the tyre pressure is too low, this leads to intensive heating of the tyres, increased tyre wear, changes in directional stability and increased fuel consumption.



#### **Note:**

If the tyre pressure is too high, this results in a longer braking distance, poorer tyre grip and increased tyre wear.



#### **Caution:**

Caps on the tyre valves protect the valve inserts from moisture and dirt. The caps on the tyre valves should therefore always be screwed on tightly.

### Tyre tread

#### Tyre tread

A minimum tyre tread depth is specified by law. Comply with the legal specifications for the relevant country.

As the remaining tread depth reduces, the less effective the road grip and handling characteristics of the bus become, particularly on wet or snowy roads.

In the interest of safety, have the tyres replaced before the legally-specified minimum tread depth is reached.



#### **Danger.**

Always ensure that there is sufficient tyre tread. Insufficient tyre tread depth increases the risk of aquaplaning if the bus is driven at high speed during heavy rain or in slush. The tyre tread can no longer deflect the water away. This could result in you losing control of your bus and causing an accident, thereby injuring yourself and other people.

#### Tyre condition

Before setting off, check the tyres on the bus for:

- external signs of damage
- foreign objects in the tyre tread
- foreign objects between twin tyres
- cracks, bulges



#### **Note:**

Please note that cracks, bulges or external damage can cause a tyre to burst. This could result in you losing control of the bus and causing an accident, thereby injuring yourself and other people. Have damaged tyres replaced immediately.

#### Tyre age

Have the tyres changed at least every six years, irrespective of wear. This also applies for the spare wheel.



#### **Danger.**

The sun's rays and environmental factors cause tyres to age. The rubber from which the tyre is made loses elasticity. Tyres harden and become brittle, cracks appear due to ageing. Tyres which are more than six years old are no longer reliable.

### Invisible tyre damage

Avoid crushing tyres against the kerb or switching off the bus when a part of the tyre tread is up on the kerb.



#### Danger.

Driving over the edge of the kerb or sharp edged objects can cause damage to the tyre substructure which is not visible externally. Damage to the tyre substructure only becomes noticeable much later and could cause the tyre to burst. This could result in you losing control of your bus and causing an accident, thereby injuring yourself and other people.

### Tyre load capacity, top speed of tyres and types of tyres



#### Danger.

Exceeding the specified tyre load capacity or the approved maximum tyre speed could lead to tyre damage or tyre failure. This could result in you losing control of your bus and causing an accident, thereby injuring yourself and other people. For this reason, only use the approved tyre types and sizes for your bus model and note the required tyre load capacity and speed index for your bus. Pay particular attention to country-specific tyre approval regulations. These regulations may specify a particular type of tyre for your bus or prohibit the use of particular tyre types that may be approved in other countries. In addition, it may be advisable to use a specific type of tyre in certain regions or areas of use. You can obtain information on tyres from any EvoBus Service Partner.

Where twin tyres are fitted, the twin tyres must have the same external diameter, otherwise the tyre that has the

largest diameter will be overloaded. Tip: the simplest and most reliable measurement method is to check circumferences using a circumference tape.



#### Note:

The maximum tolerance for twin tyres is 0.5% of the tyre diameter. The larger tyre must always be fitted in the outboard position.

### Retreaded tyres

#### Retreaded tyres

Retreaded tyres are not inspected for EvoBus and are therefore not recommended. Existing damage is not always detected during retreading. For this reason, EvoBus cannot guarantee the safety of the bus if retreaded tyres are used.

#### Cleaning the tyres



##### **Danger.**

Risk of accident. Clean tyres and suspension air bags very carefully. Round-spray jets must not be used to clean the tyres and suspension air bags. The water jet may damage the tyres. Replace damaged tyres.



##### **Environmental protection**

Damage to the environment: only clean the bus at a washpoint intended for this purpose. Heed environmental protection measures.

#### Retightening the wheel nuts



##### **Danger.**

Risk of accident. Regularly check the wheel nuts for firm seating and retighten if necessary. Make sure that the wheel nuts on a new or changed wheel are retightened after driving for 30 miles (approximately 50 km). If new or newly lacquered wheel rims are used you must also retighten the wheel nuts after the bus has driven for 600 to 3,000 miles (approximately 1,000 to 5,000 km). Observe the tightening torques.

Wheel nut tightening torques

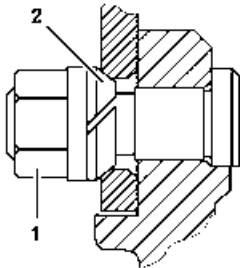

M40\_10-0001-01



**Danger.**

Risk of accident. Observe the tightening torques: pressed-steel wheel with centring by spherical spring washers (2) and wheel bolts 450 Nm.

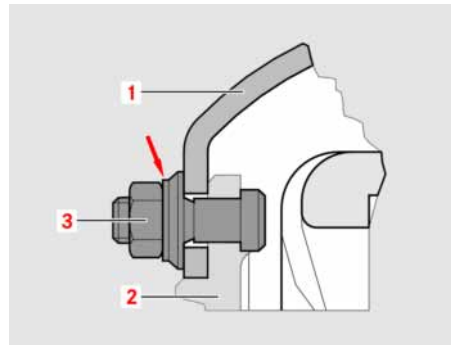

M40.00-0016-01



**Danger.**

Risk of accident. Observe the tightening torques: pressed-steel wheel with hub centring by wheel hub 600 Nm. Light-alloy wheel with hub centring 600 Nm.

Snow chains

Snow chains



**Caution:**

Snow chains must not be used on the wheels of the front axle.



**Note:**

Comply with the manufacturer's fitting instructions and legal requirements.



**Note:**

Only fine-link snow chains are permitted.



**Note:**

Raising the bus using the raising/lowering system may make it easier to fit the snow chains.

### Snow chains



#### **Danger.**

Make sure that the snow chains are fitted tightly. Do not exceed the permitted maximum speed of 25 mph (40 km/h).



#### **Note:**











Check that the snow chains are seated firmly after driving for a suitable distance (dependent upon the conditions), retighten if necessary.





## Tyre air pressure chart.

Tyre air pressure chart.

|   | [bar]   | 5,5  | 5,75 | 6,0  | 6,25 | 6,5   | 6,75  | 7,0   | 7,25  | 7,5   | 7,75  | 8,0   | 8,25  | 8,5   | 8,75 | 9,0  |
|---|---|------|------|------|------|-------|-------|-------|-------|-------|-------|-------|-------|-------|------|------|
|                   |  | 4900 | 5070 | 5240 | 5420 | 5590  | 5760  | 5930  | 6100  | 6270  | 6340  | 6500  | 6760  | 6930  | --   | --   |
|   |  | 9000 | 9320 | 9640 | 9960 | 10280 | 10600 | 10910 | 11220 | 11530 | 11840 | 12140 | 12440 | 13340 | --   | --   |
|                   |  | 4670 | 4840 | 5010 | 5180 | 5340  | 5510  | 5670  | 5830  | 5990  | 6150  | 6310  | 6480  | 6820  | --   | --   |
|   |  | 8600 | 8920 | 9230 | 9530 | 9840  | 10140 | 10440 | 10730 | 11030 | 11320 | 11610 | 11800 | 12190 | --   | --   |
|                   |  | --   | --   | --   | --   | --    | --    | 5010  | --    | 5330  | 5490  | 5690  | 5820  | 5980  | 6140 | 6300 |
|   |  | --   | --   | --   | --   | --    | --    | 9720  | --    | 10350 | 10660 | 10970 | 11265 | 11600 | --   | --   |
|  275 / 70 R 22,5 |   |      |      |      |      |       |       |       |       |       |       |       |       |       |      |      |

[bar]

Tyre air pressure in bar



Tyre size 275/70 R 22.5, load characteristic 148



Axle load for single set of tyres in kg



Axle load for twin set of tyres in kg



Axle load/air pressure rating for buses in the urban local traffic including journeys to suburbs and neighbouring towns when the average speed does not exceed 40 km/h



Axle load/air pressure rating for buses with maximum operational road speeds up to 60 km/h



Axle load/air pressure rating in recreational and holiday traffic



**Danger.**

Risk of accident. An under-inflated tyre impairs driving safety and reduces tyre life. Fuel consumption, tyre wear and risk of tyre damage are increased.



**Caution:**

Check tyre pressures regularly.



**Note:**

The values listed in the chart are recommended values for tyre size 275/70 R 22.5 - load characteristic 148. Contact the respective tyre manufacturer for special operating conditions.



**Note:**

The tyre air pressure changes by approx. 0.2 bar for each 10 °C difference in air temperature. This must be borne in mind if air pressures are checked indoors, especially in the winter.

Example: temperature in the depot approximately 20 °C, outside temperature approximately 0 °C - this means that the tyre pressure to be set = specified tyre pressure + 0.4 bar.

### Safety measures to be taken in the event of a flat tyre or a wheel change

#### Safety measures to be taken in the event of a flat tyre or a wheel change



**Danger.**

Park the bus as far away as possible from the traffic and on firm ground. Switch on the hazard warning lamps. Let all passengers disembark and move them out of the danger zone (e.g. behind the crash barrier). Position a warning triangle or hazard warning light at a suitable distance. Observe the legal requirements of the country concerned.



**Danger.**

Only change the wheel on a level, firm and non-slip surface. The bus or jack may slip out to the side on a soft or slippery surface (snow, ice, smooth surface, etc.).



**Danger.**

Never lie under the bus if it is raised up and is not supported by axle stands. Do not start the engine as there is a risk of fatal injury. Safeguard the engine against being switched on without authorisation. Remove the key from the ignition switch.

#### Jacking points



**Danger.**

Risk of accident. Secure the bus against rolling away.



**Danger.**

Risk of accident. Follow the jack manufacturer's instructions.



**Danger.**

Risk of accident. Never lie under the bus if it is raised up and is not supported by axle stands. Do not start the engine as there is a risk of fatal injury. Secure the engine against unauthorised starting, remove the key from the ignition lock.



### Danger.

Risk of accident. If the complete bus is to be raised using wheel grippers, multi-post lifts, etc., all axles must be raised simultaneously.



### Danger.

Risk of accident. The connector to the ENR (electronic level control) control unit must be disconnected for safety reasons.



### Caution:

When the bus is being lowered, make sure that the suspension air bags are seated correctly and that there is sufficient supply pressure to fill the suspension air bags again.



### Caution:

The driven axle and centre axle must never be raised in the middle.



### Caution:

The driven axle and trailing axle are connected to one another by the suspension. It is not permitted to raise an individual axle to such a height that the wheels on the second axle are lifted from the ground.



### Note:

The whole bus can be raised using the jacking points on the underbody.

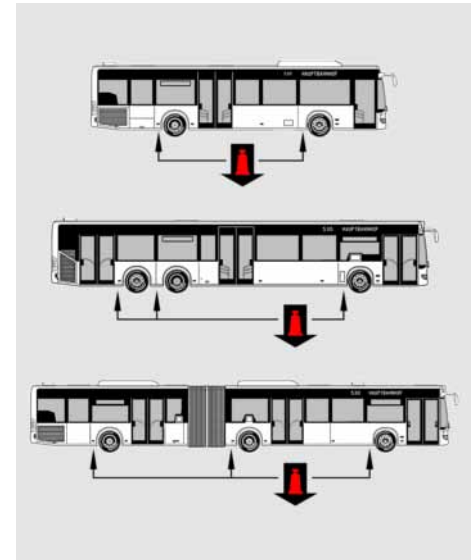

M00\_00-0509-72

- Raise the bus at the designated jacking points indicated on the underbody of the bus.

### Safety measures to be taken in the event of a flat tyre or a wheel change

#### Safety measures to be taken in the event of a flat tyre or a wheel change



**Danger.**

Park the bus as far away as possible from the traffic and on firm ground. Switch on the hazard warning lamps. Let all passengers disembark and move them out of the danger zone (e.g. behind the crash barrier). Position a warning triangle or hazard warning light at a suitable distance. Observe the legal requirements of the country concerned.



**Danger.**

Only change the wheel on a level, firm and non-slip surface. The bus or jack may slip out to the side on a soft or slippery surface (snow, ice, smooth surface, etc.).



**Danger.**

Never lie under the bus if it is raised up and is not supported by axle stands. Do not start the engine as there is a risk of fatal injury. Safeguard the engine against being switched on without authorisation. Remove the key from the ignition switch.

#### Jacking points, front



**Danger.**

Secure the bus against rolling away. Apply the parking brake.

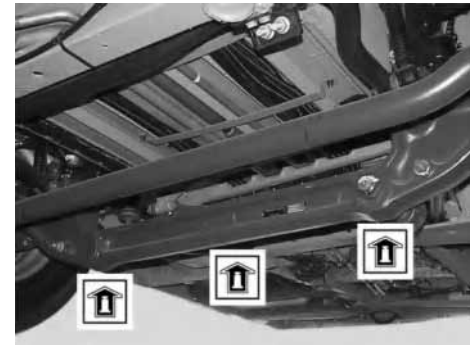

M00.00-0088-01

- Raise the bus at the jacking points on the front axle casing shown in the illustration.

Jacking points, centre (CONECTO G)

Jacking points, centre (CONECTO G)



**Danger.**

Secure the bus against rolling away. Apply the parking brake and chock the front wheels.

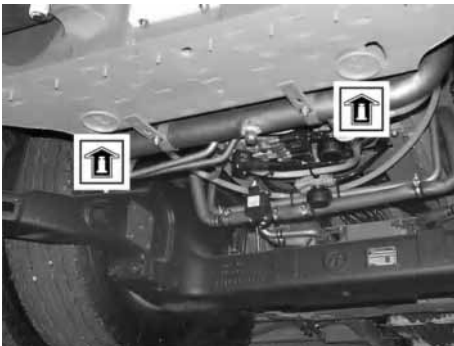

M00.00-0089-01

- ▶ Raise the bus at the jacking points at the centre of the bus underbody shown in the illustration.

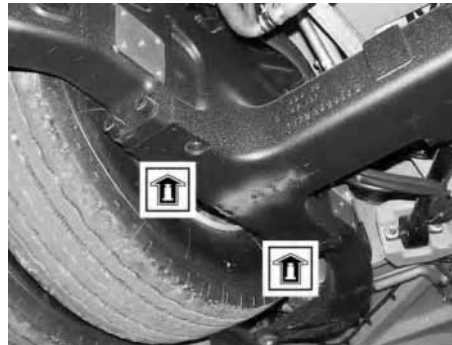

M00.00-0090-01

- ▶ Raise the bus at the jacking points on the centre axle shown in the illustration.



**Caution:**

Never position the jack at the centre of the axle casing.

Jacking points, rear



**Danger.**

Secure the bus against rolling away. Apply the parking brake and chock the front wheels.

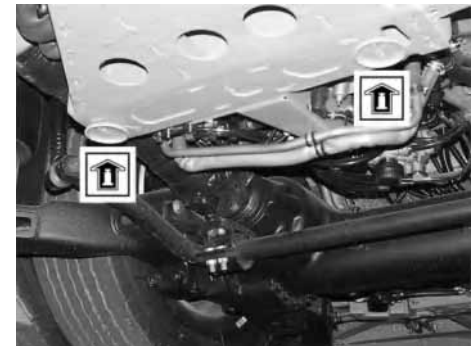

M00.00-0091-01

- ▶ Raise the bus at the jacking points at the rear of the bus underbody shown in the illustration.

### Emergency release of the drive-off lock

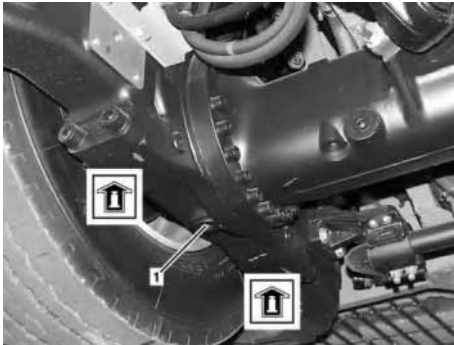

M00.00-0092-01

- ▶ Raise the bus at the jacking points on the rear axle shown in the illustration.



#### Caution:

Never position the jack against oil drain plug (1) or in the centre of the axle casing.

### Emergency release of the drive-off lock



#### Danger.

This switch has a security seal and is intended to be operated only in the event of a malfunction in the bus stop brake or drive-off lock.



#### Danger.

Make absolutely sure that the parking brake is applied before you operate the bus stop brake emergency release switch. The bus could otherwise roll away.

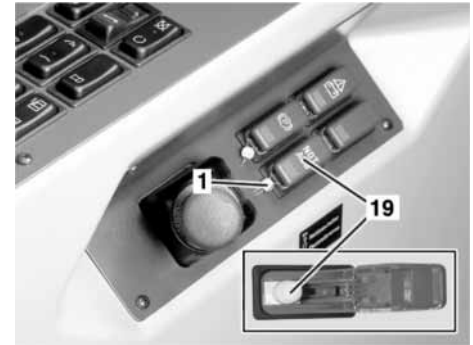

M54.00-0211-01

- ▶ Remove security seal (1).
- ▶ Open the switch cover (19).



Parking brake emergency release (option)

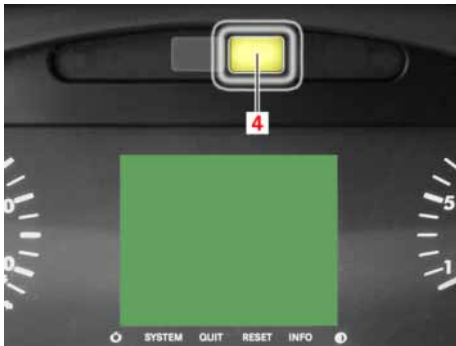

M54\_00-1363-71

- Pull switch (19).

The drive-off lock is released.

A signal sounds when the bus is stationary.

Yellow warning lamp (4) lights up when the vehicle is stationary.



M54.00-0239-01

The following is shown on the screen:  
“Bus stop brake malfunction” (B).



**Danger.**

Have the malfunction rectified as soon as possible at an EvoBus Service Partner.

Parking brake emergency release (option)



**Note:**

Precondition: auxiliary consumers operating pressure of more than 5.5 bar, parking brake valve in the released position.



**Danger.**

Risk of accident. For emergency use only. Secure the bus against rolling away before releasing the spring-loaded parking brake. Rectify faults in the brake system immediately.

### Electrical system safety precautions

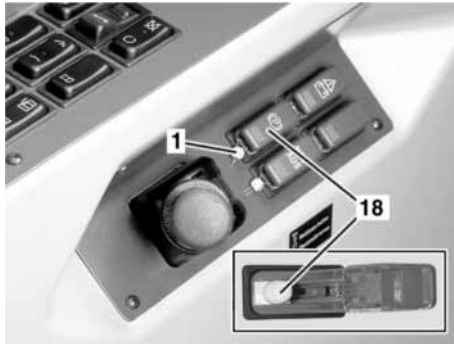

M54.00-0259-01

- ▶ Remove security seal (1).
- ▶ Open the cover of emergency release switch (18).
- ▶ Pull switch (18).

The spring actuators are released.



#### Note:

Switch off the emergency release device before restoring the bus to normal operation.



#### Note:

Provide the cover with a new security seal and secure it with wire.



#### Note:

Test regularly.

### Electrical system safety precautions

For safety reasons, always switch off the battery isolating switch before work is carried out on the electrical system or the batteries are connected/disconnected.

Do not connect or disconnect wiring harness connectors from electronic control units unless the ignition switch has been switched off.

Always protect the starter, alternator and electrical plug connections against moisture when the engine is washed.

Never bridge or repair fuses.

Only use fuses of the specified amperage. Never replace fuses with those of a higher ampere rating as this could lead to damage to the electrical system.



#### Caution:

Observe the following if the batteries are to be electrically isolated from the on-board power supply for any reason, e.g. by operation of the battery isolating switch: after switching off the engine, wait at least five minutes before isolat-

ing the battery from the on-board power supply. This delay is necessary to ensure fault-free operation of the exhaust gas cleaning system after the bus has been restored to operation.

**General safety precautions for batteries**



**Danger.**

Risk of short circuit. Do not place any metal objects on batteries.



**Caution:**

Do not loosen or disconnect the terminals when the engine is running and electrical equipment is switched on.



**Environmental protection**

Dispose of defective batteries in an environmentally responsible manner. Observe legal requirements.

**Safety precautions for handling batteries**



M54\_10-0004-01

- (1) - Fire, sparks, naked flames and smoking are forbidden. Prevent sparking.
- (2) - Risk of explosion.
- (3) - Observe the operating instructions.
- (4) - Risk of acid burns. Battery acid is corrosive. Always observe the safety instructions and safety precautions when handling batteries or battery acid. Battery acid must never come into contact with skin, eyes or clothing. Rinse off all acid splashes immediately with copious

### Battery maintenance

amounts of clean water. Seek medical attention if necessary.

(5) - Wear safety goggles.

(6) - Keep children away.



#### **Danger.**

Naked flames and smoking are strictly forbidden whenever work is being carried out on the vehicle batteries. Avoid the creation of sparks. Wear safety goggles. Keep children away. There is a risk of acid burns. The Operating Instructions must be observed. There may be a risk of explosion.



#### **Danger.**

All cells of lead-acid batteries must be fitted with special caps that are interlinked by vent hoses, thereby allowing any gases produced to be directed into the open air.



#### **Danger.**

If the bus is equipped with lead-acid batteries, it is not permitted to replace these with gel batteries. The opposite is also true.

### Battery maintenance

- Do not clean the batteries without the cell caps screwed in. Do not use petrol, benzene, kerosene or similar for cleaning.
- Ventilation bores in the cell caps must be open, i.e. the hoses in the cell ventilation must not be blocked.
- Lightly grease the terminal clamps with acid-proof grease, especially the underside.
- Check the securing screws for the terminal clamps and the screw securing the negative cable to the chassis regularly for firm seating.
- Recharge any batteries not in use once per month or trickle charge them at 0.06 A. Special chargers that have an appropriate charge characteristic (IU, IUOU or WUOU) are required for charging gel batteries.

Recharging the batteries



**Danger.**

Risk of injury. Risk of explosion.

Risk of explosion due to oxyhydrogen gas formation. Make sure that there is good ventilation when you charge the batteries.



**Caution:**

Caution. Do not rapid charge new batteries under any circumstances.

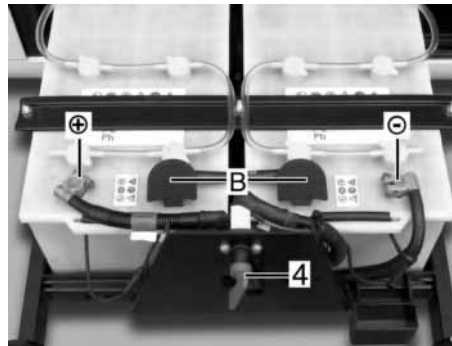

M54\_00-0686-01

- Remove the cell caps and terminal clamps from the batteries before recharging. Do not disconnect the connecting cable (B) between the batteries.
- Observe the correct charging voltage (24 volts).
- The charge current should not exceed 10 % of the battery capacity.
- Special chargers that have an appropriate charge characteristic (IU, IUOU or WUOU) are required for charging gel batteries.

Working on the electrical system and electrical fuses



**Danger.**

Risk of fire.

- Switch off all electrical equipment and disconnect the battery negative terminal clamps (-) before commencing any work on the electrical system.
- Do not reconnect the negative terminal clamps (-) until all electrical lines have been reconnected correctly.
- Switch off all electrical equipment and disconnect the battery negative terminal clamps (-) before changing an electrical fuse.
- Never bridge or repair fuses.
- Only use fuses of the specified amperage. Never replace fuses with those of a higher ampere rating as

### Measures required for the prevention of damage to buses or components during electric welding work

this could lead to damage to the electrical system.

- Always rectify the cause of the malfunction before replacing the fuse concerned.

#### Measures required for the prevention of damage to buses or components during electric welding work

To prevent damage to various components of the bus, the following measures must be taken before undertaking welding work:

- Have a fire extinguisher on standby.
- The clip on the negative terminal of the battery must be disconnected and the negative terminal covered. (Observe the notes on disconnecting the vehicle batteries.)
- The pieces of foam fitted in some of the cavities in the body as sound-proofing must be removed before the commencement of panel work, welding and tin-plating.
- Connect the earth connection of the electric welder directly to the part to be welded. When doing so, make sure that there are no electrically insulating parts between the earth connection and the weld point.
- Heat-sensitive parts, such as plastic tubes, are to be protected or removed.
- Cables routed in cavities, and containers or electronic components that have been fitted concealed, must be removed from the danger area before the start of welding.
- The passenger compartment and glazing must be covered with protective mats to protect them from weld splatter and flying sparks.
- Shield off areas at risk of damage caused by flying sparks and radiant heat.
- Do not allow the electronics housing or electrical lines to come into contact with the welding electrode or the earth connection of the welder.
- If two parts are to be welded together, both parts must be connected to the negative clip of the welder.
- The connection points for the part to be welded on the bus and the earth terminal on the electric welder must be as bare as possible – paint, cor-

Switching the on-board power supply on/off

rosion, oil, grease and dirt should therefore be thoroughly removed.

- The earth terminal of the welder must not be connected to the transmission. The welding current may cause sparking at the bearing points inside the transmission. The resultant changes in crystalline structure would lead to premature failure of the assembly.



**Danger.**

The heating effects may cause dense smoke or fires.

Switching the on-board power supply on/off



**Note:**

Precondition: battery voltage  $24 \pm 3$  volts



M54.00-0213-01

- ▶ Open the service cover for battery compartment (1).



**Note:**

The battery compartment contains the following: batteries, battery isolating switch, main fuses for on-board power supply, starter relay.

### Switching off the on-board power supply at the master safety switch

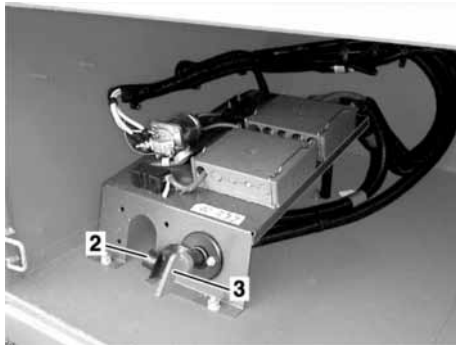

M54.00-0214-01

- ▶ Remove seal cap (2).
- ▶ Insert key (3) and turn it clockwise.  
The electrical systems and consumers are connected to the batteries.  
The on-board power supply is switched on.
- ▶ Turn key (3) anti-clockwise and remove it.



#### Caution:

Observe the following if the batteries are to be electrically isolated from the on-board power supply for any reason, e.g. by operation of the battery isolating switch: after switching off the engine, wait at least five minutes before isolating the battery from the on-board power supply. This delay is necessary to ensure fault-free operation of the exhaust gas cleaning system after the bus has been restored to operation.

The electrical systems and consumers are isolated from the batteries.

The on-board power supply is switched off.

- ▶ Refit seal cap (2).

### Switching off the on-board power supply at the master safety switch



#### Danger.

Do not operate master safety switch (17) except in an emergency and only with the bus stationary.

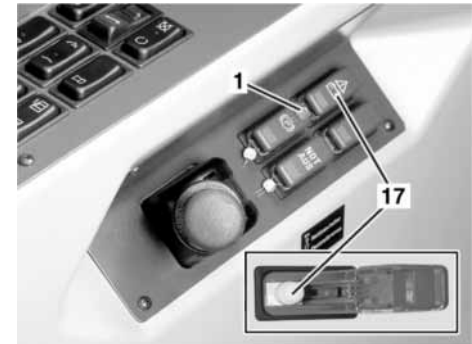

M54.00-0260-01

- ▶ Remove security seal (1).
- ▶ Open switch cover (17).



Jump-starting where vehicle batteries are located one above the other

- ▶ Pull switch (17).

The power supply is disconnected.



**Note:**

All the consumers are isolated from the batteries. Exception: hazard warning lamps with indicator, tachograph and emergency lighting

The engine stops.



**Note:**

Switch off the master safety switch before starting up the bus.



**Note:**

Provide the cover with a new security seal and secure it with wire.



**Note:**

Test regularly.

Jump-starting where vehicle batteries are located one above the other



**Danger.**

Risk of accident. Secure the bus against rolling away.

- ▶ Turn the key back to the stop in the ignition switch.

## Practical advice

### Jump-starting where vehicle batteries are located one above the other



M54\_00-0683-01

- ▶ Open the service cover for battery compartment (1).



M54\_00-0692-01

- ▶ Unscrew the retaining screws for battery support frame (2).

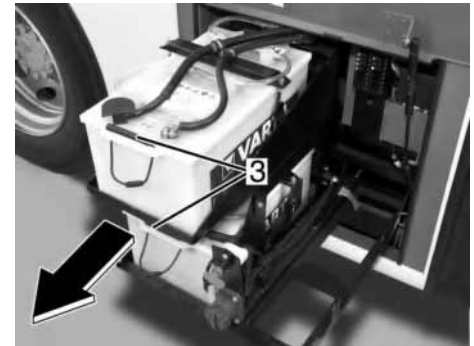

M54\_00-0691-01

- ▶ Pull the batteries on the support frame out by gripping handles (3) with both hands.

Jump-starting where vehicle batteries are located one above the other

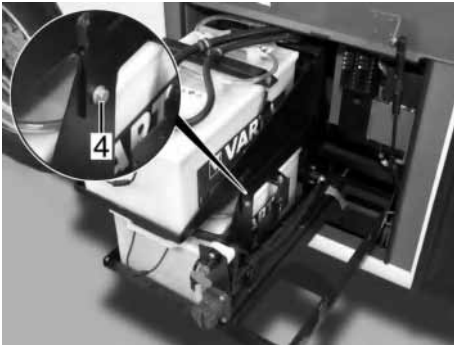

M54\_00-0690-01

- ▶ Unscrew retaining screw (4) for the upper battery support frame.



M54\_00-0687-01

- ▶ Swivel the upper battery on the support frame to the right.

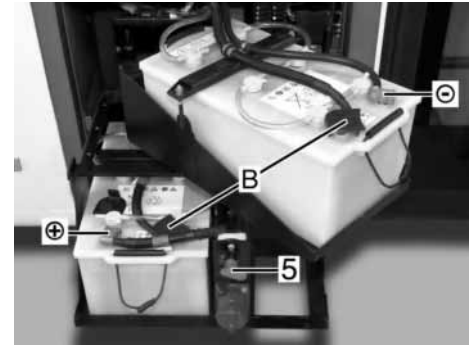

M54\_00-0689-01

- ▶ Connect one end of the positive cable to the (+) terminal of the discharged battery first, then connect the other end of the positive cable to the (+) terminal of the donor battery.



**Danger.**

Risk of injury/explosion. Do not connect the jump lead to the battery terminals (B) to which the connecting cable between battery 1 and battery 2 is connected.

### Jump-starting where vehicle batteries are mounted side by side

- ▶ Connect the negative cable to the (-) terminal on the donor battery and then the other end to an earthed metal part that is bolted onto the bus skeleton.
- ▶ Fully disconnect the earth connection of the jump leads then disconnect the positive cable.



#### Note:

As far as possible from the discharged battery.

- ▶ Run the engine of the donor vehicle at an elevated idling speed.
- ▶ Start the engine of the bus to be jump-started in the normal way and let it run at idling speed.
- ▶ Switch off the engine of the donor vehicle.



#### Note:

To prevent voltage peaks, switch on the more powerful consumers of the jump-started bus, such as the lighting, heated windows or ventilation, before you disconnect the jump leads.

### Jump-starting where vehicle batteries are mounted side by side



#### Danger.

Risk of accident. Secure the bus against rolling away.

- ▶ Turn the key back to the stop in the ignition switch.



M54\_00-0683-01

- ▶ Open the service cover for battery compartment (1).

**Jump-starting where vehicle batteries are mounted side by side**



M54\_00-0684-01

- ▶ Pull out the retaining pins for battery support frame (2).

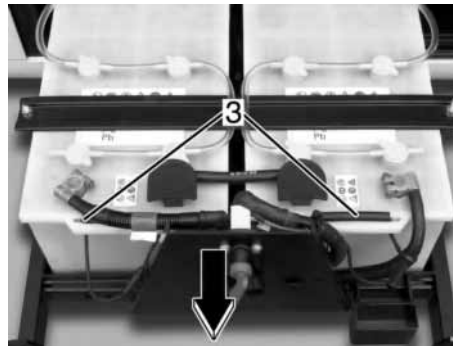

M54\_00-0685-01

- ▶ Pull the batteries on the support frame out by gripping handles (3) with both hands.
- ▶ Connect one end of the positive cable to the (+) terminal of the discharged battery first, then connect the other end of the positive cable to the (+) terminal of the donor battery.

- ▶ Connect the negative cable to the (-) terminal on the donor battery and then the other end to an earthed metal part that is bolted onto the bus skeleton.



**Note:**

As far as possible from the discharged battery.

- ▶ Run the engine of the donor vehicle at an elevated idling speed.
- ▶ Start the engine of the bus to be jump-started in the normal way and let it run at idling speed.
- ▶ Switch off the engine of the donor vehicle.

### Jump-starting a bus fitted with a battery charging socket

- ▶ Fully disconnect the earth connection of the jump leads then disconnect the positive cable.



#### Note:

To prevent voltage peaks, switch on the more powerful consumers of the jump-started bus, such as the lighting, heated windows or ventilation, before you disconnect the jump leads.

### Jump-starting a bus fitted with a battery charging socket



#### Danger.

Risk of accident. Secure the bus against rolling away.

- ▶ Turn the key back to the stop in the ignition switch.



M54\_00-0683-01

- ▶ Open the service cover for battery compartment (1).

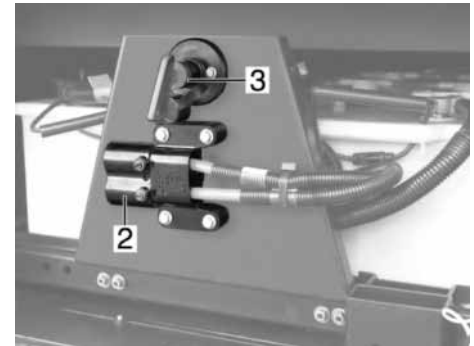

M54\_00-0693-01

- ▶ Connect a suitable jump lead to battery charging socket (2).



#### Note:

Specifications: manufactured by Fenwick

**Opening the emergency exit in the roof**

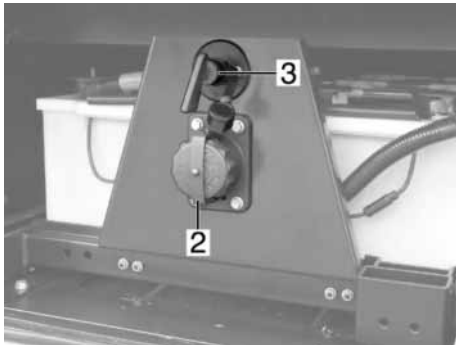

M54\_00-0694-01

- ▶ Connect a suitable jump lead to battery charging socket (2).



**Note:**

Specifications: Nato socket

- ▶ Run the engine of the donor vehicle at an elevated idling speed.
- ▶ Start the engine of the bus to be jump-started in the normal way and let it run at idling speed.

- ▶ Switch off the engine of the donor vehicle.
- ▶ Disconnect the jump leads.



**Note:**

To prevent voltage peaks, switch on the more powerful consumers of the jump-started bus, such as the lighting, heated windows or ventilation, before you disconnect the jump leads.

**Opening the emergency exit in the roof**



M77\_00-0025-71

- ▶ Pull the cover down using handle (1).

### Opening the emergency exit in the roof



M77\_00-0014-01

- ▶ The emergency operation is triggered using a red rotary handle on the inside or outside (1).



#### Note:

In emergencies, the twistgrip on the inside (1) must be turned in the direction of the arrow (clockwise). The emergency exit cover can now be secured by a safety rope and placed to one side outside the bus.



#### Danger.

The covers for the roof emergency exit hatches must be fitted by skilled personnel at an EvoBus Service Partner following the emergency operation.

- ▶ On an articulated bus, an emergency hammer is located in the roof of the rear car underneath the emergency exit cover. In an emergency, the hammer can be used to break the glass panel in the emergency exit.



#### Danger.

If the panel is broken with the emergency hammer, there will be a risk of injury from flying glass splinters. Protect your hands and eyes.



#### Danger.

Care should be taken when disembarking through a window. There is a risk of cutting yourself.



Note on maintenance work

Note on maintenance work



**Note:**

All the maintenance work is described in special instructions. The tasks listed here are not subject to any specific maintenance interval, rather they must be carried out depending on the conditions of vehicle use.

Cleaning the underbody



**Note:**

The underbody refers to the entire underbody of the bus, including the bus floor, the wheel housings and the underbody carcass.



**Note:**

The underbody should be inspected at regular intervals and cleaned according to the level of dirt, but at least once a year in conjunction with the annual maintenance service. This enables underbody protection coating which is flawed or damaged to be identified and remedied in good time.

Cleaning the underbody with a hot-water high-pressure cleaner



**Note:**

Remove the protective cladding on the underbody and clean it separately.



**Note:**

The underbody is protected by protective coatings against corrosion and stones being thrown up. Clean as carefully as possible to avoid washing off or damaging the good protective layers. Match the water temperature and pressure to the spray nozzle and spraying distance appropriately.



**Note:**

The underbody should be washed primarily using clean water. Only use a cleaning product on dirt which is very difficult to remove.

### Cleaning the underbody



#### Environmental protection

Observe waste water guidelines. Only clean the bus in an area appropriately equipped for cleaning.

- ▶ Inspect the underbody and pay attention to damage and an unusually heavily impregnated and discoloured dirt layer.



#### Note:

It will be possible to detect faults on the dirty underbody which will no longer be visible after cleaning. For example, leaking unions on oil, fuel and coolant pipes and reservoirs, leaking points on assemblies, hidden corrosion in the stained layers of dirt may be detected. Remedy any faults and damage remaining after cleaning.

- ▶ Use a hot-water high-pressure cleaner in accordance with the manufacturer's instructions.

#### Organisational resource

Hot-water high-pressure cleaner

Alfred Kärcher GmbH & Co.

Wap-Reinigungssysteme GmbH & Co



#### Danger.

Risk of injury due to improper use of the high-pressure cleaner and damaged accessories. Observe the manufacturer's operating instructions, comply with safety notes and wear protective clothing.

- ▶ Mix cleaning products with the washing water if necessary according to the manufacturer's instructions or in the concentration given on the container intended for use on the unit.

#### Repair agent

RM 55 XXL

Alfred Kärcher Vertriebs-GmbH

#### Repair agent

P3-grato 80

Henkel KGaA

#### Repair agent

HAKAPUR 50-268

CHEMISCHE WERKE KLUTHE GmbH



#### Danger.

Risk of injury from corrosive components in the cleaning products. Follow the manufacturer's safety instructions.



#### Caution:

Only use recommended cleaning products. Unsuitable cleaning products could damage the bus. Highly concentrated cleaning products must be diluted according to the manufacturer's instructions.

- ▶ Fit the spray lance with a flat-spray jet or use a variable adjustable nozzle to set the spray angle.

**Setting values**

| Designation                                 | Value |
|---|-------|
| Spray angle of the flat jet nozzle at least | 25°   |



**Caution:**

Round-spray jets and power-concentrated jets must not be used. The effect of the water jet on these tools is too aggressive for cleaning the bus and could cause serious damage to the bus.



**Note:**

The nozzle spraying angle determines the level of cleaning. The greater the nozzle spraying angle, the more protection offered when cleaning.

- ▶ Set the water pressure, water temperature and the concentration of the cleaning product on the high-pressure cleaner.

**Setting values**

| Designation                        | Value  |
|------------------------------------|--------|
| Maximum permissible water pressure | 60 bar |

**Setting values**

| Designation                           | Value |
|---------------------------------------|-------|
| Maximum permissible water temperature | 60 °C |



**Caution:**

The protective coating on the underbody or components may be damaged if the water pressure and/or water temperature are too high or a wrong spray nozzle is fitted.



**Caution:**

The addition and concentration of the cleaning products should be adjusted according to the type and level of dirt on the area to be cleaned. Excess cleaning product can cause damage.

- ▶ Turn on the water jet pointing it towards the ground or open-air and then move it onto the surface to be cleaned. Maintain the maximum permitted jet distance.

**Setting values**

| Designation                             | Value |
|---|-------|
| Spray distance from the object at least | 30 cm |

### Cleaning the underbody



#### Danger.

Risk of injury from hot water. The spray lance could rebound if the jet hits the surface to be cleaned directly from a short distance.



#### Danger.

Risk of injury from high pressure and hot water. Do not direct the spray lance at animals or people.

- ▶ Spray the layer of dirt on the underbody thoroughly with the water jet.



#### Note:

Let the sprayed water take effect. You may need to spray several times, depending on the level of dirt.



#### Note:

Pay particular attention to dirt deposits in corners, cavities, wheel housings and on lines, as well as between the ramp and underbody.

- ▶ Rinse the layer of dirt on the underbody with a high-pressure water jet.



#### Danger.

Do not direct high-pressure jets directly on to tyres, suspension air bags or brake hoses, special hose connections made of rubber, gaiters and mountings of moving parts, electrical lines, components and their connections. Move the high-pressure jet continually and change the direction at which it hits the surface to be cleaned.



#### Note:

Only direct the high-pressure jet at seams, gaps or cavities for brief periods. Water penetrating deep into the bus, enhanced by the cleaning product, could lead to hidden corrosion and weaken supporting components of the carcass.

- ▶ Stop using the cleaning product and rinse the entire underbody area with water.



#### Note:

Cleaning products should not be allowed to dry on. Cleaning agent residues may permanently damage surfaces and especially movable parts.

- ▶ Clean openings and drainage holes for condensate in pipes, sections and cavities by hand, e.g. with a pen.



**Note:**

Do not wash out drainage openings using a pressure cleaner. The openings guarantee that any water or condensation which has penetrated during cleaning can drain out or dry.

- ▶ Let the underbody dry.



**Caution:**

Do not blow away any remaining moisture using compressed air.

- ▶ Finally, carry out a visual inspection of the underbody.



**Note:**

During the visual inspection, look in particular for complete and undamaged protective coating (wax and stone impact protection) and corrosion damage. Also check for damage to tyres, suspension air bags, brake hoses, sealing gaiters and bearings for moving parts, as well as electrical lines and their connections.



**Note:**

Repair established faults or damage properly and lubricate mountings and joints. Replace damaged tyres, suspension air bags and pressure hoses.

- ▶ Carry out a test run with a braking test and observe the operation of the level control.



**Note:**

Have any faults remedied professionally.



**Vehicle data** ..... **254**

## Vehicle data

| Vehicle data  |  |
|---|--|
| Designation   | Value  |
| Vehicle length  | CONNECTO:  |
| Bumper-to-bumper length                                   | 11,950 mm<br>CONNECTO G:<br>17,940 mm              |
| Vehicle width   | 2,550 mm   |
| Production version  |  |
| Vehicle height including roof ventilators                 | 3,056 mm   |
| Vehicle height including air-conditioning system (option) | 3,076 mm   |
| Permissible gross vehicle weight                          | CONNECTO:<br>19,000 kg<br>CONNECTO G:<br>28,000 kg |
| Track width, front axle                                   | 2,113 mm   |

| Designation              | Value  |
|--------------------------|--|
| Track width, driven axle | 1,834 mm   |
| Wheelbase                | CONNECTO:<br>5,845 mm<br>CONNECTO G:<br>5,845 mm   |
| Wheelbase 2nd-3rd axle   | CONNECTO G:<br>5,990 mm                            |
| Track circle             | CONNECTO:<br>17,484 mm<br>CONNECTO G:<br>19,002 mm |
| Turning circle           | CONNECTO:<br>21,542 mm<br>CONNECTO G:<br>22,822 mm |
| Front overhang           | 2,705 mm   |

| Designation                 | Value  |
|-----------------------------|--|
| Rear overhang               | CONNECTO:<br>3,400 mm<br>CONNECTO G:<br>3,400 mm |
| Angle of approach           | 7°   |
| Angle of departure          | 7°   |
| Pitch angle (CONNECTO G)    | max. 10°   |
| Total fuel tank volume      | CONNECTO:<br>280 l                               |
| AdBlue additive tank volume | CONNECTO:<br>35 l                                |
| Windscreen washer reservoir | Approximately<br>8 l                             |



**A****Acceleration skid control (ASR)**

activating/deactivating . . . . . 31

**AdBlue**

Service product . . . . . 37

**Air-conditioning system**

Operating instructions . . . . . 161

Safety precautions . . . . . 161

**Anti-jackknifing protection**

during forward travel . . . . . 47

during reverse travel . . . . . 48

**Automatic transmission**

Gearshift positions of the 3-  
pushbutton switch panel . . . . . 153

Gearshift positions of the 6-  
pushbutton switch panel . . . 154-157

General information . . . . . 152

**Auxiliary heating**

Safety precautions . . . . . 8-9

**B****Batteries**

Care . . . . . 234

Recharging . . . . . 235

Safety precautions . . . . . 233

**BlueTec exhaust gas cleaning**

system . . . . . 35-36

**Brake pressure/supply pressure** . 27

**Brakes with anti-locking protection** . . . . . 26

**Braking and stopping** . . . . . 26

**Bus stop brake**

activating/deactivating . . . . . 139

**C****Care and cleaning**

Cleaning the underbody . . . 247-251

Covers and upholstery . . . . . 59

Fabric covers . . . . . 60

Leather covers . . . . . 63-64

Micro-fibre covers . . . . . 61-62

Safety precautions . . . . . 57

Tilting seats (with square-drive  
lock) . . . . . 59

Tilting the rear seats . . . . . 58

**D****Departure check**

Daily tasks . . . . . 12

Weekly tasks . . . . . 13

**Doors**

Emergency operation . . . . . 192-193

Locking door 1 with the key  
(option) . . . . . 197

Locking/unlocking door leaves  
from the outside . . . . . 195

Opening/closing door 1 from  
the outside . . . . . 194-196

**Drive-off lock** . . . . . 140

emergency release . . . . . 230

**Driver's area**

Overview . . . . . 68

Side panel . . . . . 73-75

Switches on the left section of  
the instrument panel . . . . . 69-70

Switches on the right section of  
the instrument panel . . . . . 71-72

**Driver's seat**

Grammer MSG 90.5 . . . . . 148-149

**Driving** . . . . . 20

**E****Electric cassette ramp**

Retracting/extending the  
electric ramp . . . . . 54-55

## Electrical system . . . . . 235

Jump-starting a bus fitted with a battery charging socket . . . . . 244

Jump-starting where vehicle batteries are located one above the other . . . . . 239-241

Jump-starting where vehicle batteries are mounted side by side . . . . . 242-243

Measures required for the prevention of damage . . . . . 236

Safety precautions . . . . . 232

Switching off the on-board power supply at the master safety switch . . . . . 238

Switching the on-board power supply on/off . . . . . 237

## Emergency equipment . . . . . 84-85

### Engine

Starting . . . . . 18-19

Stopping . . . . . 21

## H

### Heating/ventilation/air-conditioning

Additional driver's area ventilation (option) . . . . . 169

Driver's area - adjusting the blower speed . . . . . 167

Driver's area - adjusting the temperature . . . . . 166

Driver's area - cooling . . . . . 168

Driver's area - setting the air distribution/demisting the windscreen . . . . . 165

Driver's area control panel . . . . . 75, 162-163

Fans on/off . . . . . 181

Passenger compartment - switching temperature control on and off - code HH2/HK1 . . . . . 170

Passenger compartment - switching temperature regulation on and off . . . . . 171

Passenger compartment control panel . . . . . 164

Passenger-compartment temperature - changing the base value . . . . . 175-178

Switching air-recirculation mode on and off . . . . . 169

Switching fans on and off - code HH2/HK1 . . . . . 182-183

Switching the auxiliary heating on and off . . . . . 172-173

Switching the reheat function on and off . . . . . 174

## I

Identification plate . . . . . 1

Ignition switch . . . . . 69, 98

Instrument cluster . . . . . 76-79

Display control . . . . . 73

## J

### Jacking points

centre . . . . . 229

front . . . . . 228

General information . . . . . 226-227

rear . . . . . 229

## M

### Malfunction displays

Red warning level - overview 118-119

Warning level C - overview . . . . 128

Yellow warning level A - overview . . . . . 122-123

Yellow warning level B - overview 126

**Master safety switch  
(emergency-off switch)** . . . . . 75, 100

**Mirror and window heating**  
activating/deactivating . . . . . 143-144

## N

**Note symbols** . . . . . 4

## O

**Opening the emergency exit  
in the roof** . . . . . 245-246

**Opening the hinged window** . . . . . 56

**Operating/malfunction displays**  
ABS/ASR . . . . . 31-32  
Brake system . . . . . 28-30  
Fuel system . . . . . 46

## P

**Parking brake**  
emergency release (option) . . . . . 231  
General information . . . . . 99  
Releasing . . . . . 137

## R

**Raising/lowering system**  
Lowering/raising the bus on  
the entry side . . . . . 132-133

Raising the bus above normal  
level . . . . . 134-135

**Ramp**  
folding in/out . . . . . 52-53

**Ramp request** . . . . . 50

**Refuelling**  
AdBlue . . . . . 44-45  
Diesel fuel . . . . . 33  
Opening/closing the fuel filler  
cap . . . . . 42-43

**Roof hatches** . . . . . 179-180

**Rotary light switch** . . . . . 71, 91

**Running-in guideline** . . . . . 18

## S

**Screen**  
Malfunction displays . . . . . 116  
Malfunction displays: red warning  
level . . . . . 117  
Malfunction displays: warning  
level C . . . . . 127  
Malfunction displays: yellow  
warning level A . . . . . 120  
Malfunction displays: yellow  
warning level B . . . . . 124

Selecting the language . . . . . 129-130

**Seat belt**  
Driver's seat . . . . . 150

**Snow chains** . . . . . 216, 221-222

**Steering column**  
adjusting . . . . . 142

**Steering column switch**  
Light and wiper functions . . . . . 92  
Retarder and cruise control . . . . . 69, 92-97

**Stop request** . . . . . 49

## T

**Tachograph**  
Display . . . . . 83  
DTCO . . . . . 69, 82  
MTCO . . . . . 69, 80-81

**Towing** . . . . . 22

**Towing coupling**  
front . . . . . 23

**Towing coupling**  
rear . . . . . 24

**Tyres**  
Cleaning the tyres . . . . . 215, 220  
Flat tyre . . . . . 226, 228  
Invisible tyre damage . . . . . 214, 219

- Operating safety and roadworthiness . . . . . 213, 217
- Retreaded tyres . . . . . 215, 220
- Tyre age . . . . . 214, 218
- Tyre air pressure chart. . . . . 224-225
- Tyre condition . . . . . 214, 218
- Tyre load capacity, top speed of tyres and types of tyres . . . . . 214, 219
- Tyre pressure . . . . . 213, 217
- Tyre tread . . . . . 213, 218

## **Tyres/wheels**

- Retightening the wheel nuts 215, 220
- Wheel nut tightening torques . . . . . 215, 221

## **V**

### **Vehicle key**

- Overview . . . . . 66-67

## **W**

**Windscreen washer reservoir . 86-87**

**Winter operation . . . . . 38**